

Prospectus

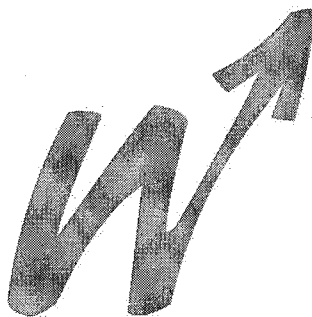

RÉGION WALLONNE

EUR 743,500,000

Multi-currency Treasury Notes Programme

Under the Multi-currency Treasury Notes Programme described in this presentation document (hereinafter the "**Programme**" and the "**Prospectus**" respectively), Région wallonne (the "**Issuer**"), subject to compliance with all relevant laws, regulations and directives, may from time to time issue "*Billets de Trésorerie/Thesauriebewijzen*" (the "**Treasury Notes**" or the "**Notes**"). The aggregate nominal amount of Treasury Notes outstanding will not at any time exceed EUR 743,500,000 (or the equivalent in foreign currencies).

The issue of Treasury Notes is organised by the Law of 22 July 1991 on treasury notes and certificates of deposit (as amended) and the Royal Decree of 14 October 1991 on treasury notes and certificates of deposit (as amended). This Prospectus includes the "prospectus" referred to in article 5 of the Law of 22 July 1991 on treasury notes and certificates of deposit.

The Programme permits Notes to be issued which are unlisted and/or not admitted to trading on any market. The Programme also permits Notes to be issued which are listed or admitted to listing, trading and/or quotation by such listing authorities, stock exchanges and/or quotation systems as may be agreed between the Issuer and the Dealer (as defined below). This Prospectus, as supplemented if required by the rules of the relevant listing authorities, stock exchanges and/or quotation systems, shall constitute a listing prospectus when read together with the relevant Pricing Supplement.

The Treasury Notes will be in dematerialised form and will not be exchangeable for bearer notes (whether in global or definitive form) or registered notes. They will be cleared through the securities clearing system recognised or approved in accordance with Articles 3 to 12 of the Law of 2 January 1991 on the market of public debt securities and the monetary policy instruments (as amended), the Law of 6 August 1993 regarding certain securities transactions (as amended) and its implementing decrees, the Law of 15 July 1998 regarding the amendment of certain legal provisions on financial instruments and securities clearing systems (as amended) and its implementing decrees and the Law of 2 August 2002 on supervision of the financial industry and financial services (as amended), which is currently the X/N securities clearing system operated by the National Bank of Belgium (hereinafter the "**Clearing System**" and the "**Clearer**" respectively). Euroclear bank S.A. / N.V. as operator of the Euroclear System ("**Euroclear**") and Clearstream Banking, société anonyme ("**Clearstream, Luxembourg**") maintain accounts in the Clearing System. The clearing of the Treasury Notes through the Clearing System must receive the prior approval of the Clearer.

The Issuer may, subject to compliance with all relevant laws, regulations and directives, agree with the Dealer (as defined below) that Notes may be issued in a form not contemplated by the Terms and Conditions, in which event a supplementary prospectus, if appropriate, will be made available which will describe the effect of the agreement reached in relation to such Notes.

The Belgian Law of 16 June 2006 on the public offering of investment instruments and the admission of investment instruments to trading on a regulated market does not apply to the offer of the Notes issued under the Programme or to the Prospectus. The Prospectus does not constitute a prospectus pursuant to the Prospectus Law implementing the Prospectus Directive (Directive 2003/71/EC) into Belgian law. Accordingly, this Prospectus does not purport to meet the format and disclosure requirements of the Prospectus Regulation (Commission Regulation (EC) N° 809/2004) and it has not been, and will not be, submitted for approval to any competent authority within the meaning of the Prospectus Directive. The Notes issued under the Programme will therefore not qualify for the benefit of the single European passport pursuant to the Prospectus Directive.

Arranger, Domiciliary Agent & Dealer



BNP PARIBAS
FORTIS

This Prospectus dated 19 February 2010 amends and replaces the prospectus dated May 2001.

CONTENTS

	Page
AFFIDAVIT	3
IMPORTANT NOTICE	4
DOCUMENTS INCORPORATED BY REFERENCE	7
OVERVIEW OF THE PROGRAMME	8
TERMS AND CONDITIONS OF THE PROGRAMME	11
1. INTRODUCTION	11
2. INTERPRETATION AND DEFINITIONS	11
3. FORM OF THE TREASURY NOTES	15
4. CLEARING SYSTEM	15
5. CURRENCY	15
6. STATUS OF THE TREASURY NOTES	15
7. NEGATIVE PLEDGE	16
8. ISSUE PRICE	16
9. INTEREST AMOUNTS	16
10. REDEMPTION OF THE TREASURY NOTES	18
11. PAYMENTS	19
12. SELLING RESTRICTIONS	19
13. TAXATION	19
14. EVENTS OF DEFAULT	20
15. MEETINGS OF NOTEHOLDERS	21
16. FURTHER ISSUES	21
17. NOTICES	21
18. GOVERNING LAW AND JURISDICTION	21
FORM OF PRICING SUPPLEMENT	22
DESCRIPTION OF THE ISSUER	29
THE ISSUER AND ITS FINANCES	29
1. INSTITUTIONS, POWERS AND ECONOMIC SITUATION OF THE ISSUER	30
2. FINANCES AND BUDGETS OF THE ISSUER	36
3. THE CASH AND DEBT MANAGEMENT OF THE ISSUER	40
TAXATION IN BELGIUM	45
1. DESCRIPTION OF THE BELGIAN CLEARING SYSTEM	45
2. BELGIAN TAXATION	46
3. SAVINGS DIRECTIVE	49
SELLING RESTRICTIONS	50
EXEMPT ACCOUNT HOLDERS	52
GENERAL INFORMATION	54

AFFIDAVIT

The Issuer having made all reasonable enquiries, confirms that, to the best of its knowledge and belief: (i) this Prospectus contains all information with respect to the Issuer and the Treasury Notes to be issued under the Programme, which is material in the context of the Programme, (ii) the information contained in the Prospectus is true and accurate in all material respects and is not misleading, (iii) the opinions and intentions expressed in the Prospectus are honestly held and (iv) there are no other facts the omission of which would, in the context of the Programme and the issuance of Notes thereunder, make any of such information or the expression of any such opinions or intentions misleading in any material respect.

Without prejudice to the preceding paragraph, the Issuer accepts responsibility towards interested parties for the losses which may occur as an immediate and direct result of the absence or inaccuracy of any disclosure required to be made in the Prospectus pursuant to article 5 of the Law of 22 July 1991 on treasury notes and certificates of deposit and in accordance with the terms of the Royal Decree of 14 October 1991 on treasury notes and certificates of deposit. The Issuer confirms having made all reasonable inquiries to ascertain all material facts for the purposes aforesaid.

For the Issuer

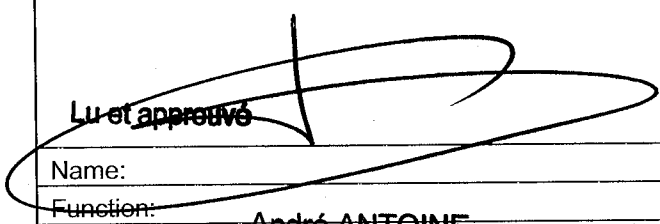
Lu et approuvé
Name:
Function: André ANTOINE Ministre du Budget et des Finances

IMPORTANT NOTICE

The issue of Treasury Notes is organised by the Law of 22 July 1991 on treasury notes and certificates of deposit (*Loi relative aux billets de trésorerie et aux certificats de dépôt / Wet betreffende de thesauriebewijzen en de depositobewijzen*) (as amended) (the "**Law**") and the Royal Decree of 14 October 1991 on treasury notes and certificates of deposit (*Arrêté royal relatif aux billets de trésorerie et aux certificats de dépôt / Koninklijk Besluit betreffende de thesauriebewijzen en de depositobewijzen*) (as amended) (the "**Royal Decree**"). The Issuer is entitled to issue Treasury Notes further to article 3 of the Law.

The Prospectus has been prepared for the purpose of giving information with regard to the Issuer and the Notes. The Issuer accepts responsibility for the information contained in this Prospectus.

The Issuer confirms that the Prospectus contains all such information as the investors would require, taking into account the characteristics of the relevant transaction, in order to make an assessment about the transaction and the rights attached to the Notes.

For the avoidance of any doubt, this Prospectus applies only to the Treasury Notes to be issued by the Issuer as from the date of this Prospectus and has no impact on the treasury notes outstanding on the date of this Prospectus.

Neither the delivery of this Prospectus nor the offering, sale or delivery of any Note shall, in any circumstances, create any implication that the information contained in this Prospectus is true subsequent to the date hereof or the date upon which this Prospectus has been most recently supplemented or that there has been no adverse change or any event reasonably likely to involve any adverse change in the prospects or financial position of the Issuer since the date thereof or, if later, the date upon which this Prospectus has been most recently supplemented, or that any other information supplied in connection with the Programme is correct at any time subsequent to the date on which it is supplied, or if different, the date indicated on the same.

The Arranger (as defined below) and the Dealer (as defined below) did not verify the information contained in the Prospectus. Accordingly no warranty or undertaking, expressed or implied opinion, is made and no responsibility or liability is accepted by the Arranger or the Dealer regarding the accuracy or completeness at any time of this Prospectus or any further information given in connection with this Programme. Neither the Arranger nor the Dealer undertake to advise any investor in the Notes about any information and may not be held responsible by the investors for the inaccuracy or incompleteness of information supplied. Neither the Arranger nor the Dealer undertake to review the financial condition or affairs of the Issuer during the life of the arrangements contemplated by this Prospectus nor to advise any investor or potential investor in the Notes of any information coming to the attention of the Arranger or the Dealer.

No person or organisation has been authorised by the Issuer, the Arranger or the Dealer to give any information or to make any representation not contained in the Prospectus and, if given or made, such information or representation must not be relied upon as having been authorised by the Issuer, the Arranger or the Dealer.

This Prospectus does not constitute, nor may it be used for the purpose of an offer, invitation or solicitation by anyone in any jurisdiction or in any circumstances in which such offer, invitation or solicitation is not authorised or to any person to whom it is unlawful to make such offer, invitation or solicitation.

This Prospectus does not constitute an offer of, or an invitation by or on behalf of the Issuer, the Arranger or the Dealer to subscribe for or purchase, any Notes and should not be considered as a recommendation by the Issuer, the Arranger, the Dealer or any of them that the recipient of this Prospectus should subscribe for or purchase any Notes. Each recipient shall be deemed to have made its own investigation and appraisal of the condition (financial or otherwise) and affairs of the Issuer and its own appraisal of the creditworthiness of the Issuer.

The distribution of this Prospectus and the offering or sale of Notes in certain jurisdictions may be restricted by law. Persons into whose possession this Prospectus comes are required by the Issuer, the Arranger and the Dealer to inform themselves about and to observe any such restrictions. The Notes have not been and will not be registered under the United States Securities Act of 1933, as amended. Subject to certain exceptions, Notes may not be offered, sold or delivered within the United States or to U.S. persons. For a description of certain restrictions on offers and sales of Notes and on distribution of this Prospectus please refer to the section entitled "Selling Restrictions" of this Prospectus.

The applicable terms of the relevant Tranche (as defined hereafter) of Notes will be agreed between the Issuer and the Dealer prior to the issue of the Notes and will be specified in a pricing supplement (hereinafter the "**Pricing Supplement**"). The Pricing Supplement shall be deemed to be part of the Prospectus. The Terms and Conditions applicable to the Notes issued under this Programme are detailed below (subject to the completion and amendment in accordance with the relevant Pricing Supplement). Information about drawings under the Programme will be published by the National Bank of Belgium.

Fortis Bank NV/SA, acting in Belgium under the commercial name of BNP Paribas Fortis ("**BNP Paribas Fortis**"), has been appointed by the Issuer as its domiciliary agent (the "**Domiciliary Agent**") through an issuing and paying agency agreement entered into on 10 November 1994 as amended, restated or supplemented from time to time. Therefore every holder of Treasury Notes (a "**Noteholder**") may require from the Domiciliary Agent the delivery of the Prospectus (including, for the avoidance of doubt, the relevant Pricing Supplement). A copy of this document will be available at the offices of the Domiciliary Agent and the Issuer set out at the end of this Prospectus during normal business hours so long as any Notes are outstanding.

The Domiciliary Agent shall act, in connection with such appointment or under the Notes, solely for and upon the instructions of the Issuer and shall incur no liability for or in respect of any action taken by it pursuant to such instructions, nor shall it have any obligations to, or a relationship of agency or trust with, any of the owners of Notes.

BNP Paribas Fortis has been appointed by the Issuer as arranger (the "**Arranger**"), and as dealer (the "**Dealer**") under the Programme through a dealer agreement entered into on 10 November 1994 as amended, restated or supplemented from time to time. The Dealer represents and agrees that it has not taken, and will not take any steps which would constitute or result in a public offering or distribution of the Notes in any country or any jurisdiction where action for that purpose is required. More specifically, but without limitation, potential purchasers are informed that, in accordance with the Law as amended from time to time, this Prospectus has not been notified or submitted for approval to the Banking, Finance and Insurance Commission in Belgium.

As of the date of the Prospectus, the OTC market for Belgian Treasury Bills and for Belgian Commercial Paper is a non-regulated market accepted by the European Central Bank (the "**ECB**") regarding eligible assets. Nevertheless, this constitutes only one of the criteria imposed by the ECB and other relevant criteria shall be checked on a case by case basis to eventually have a Tranche of Notes being considered as eligible by the ECB as collateral for Eurosystem credit operations.

The Law of 16 June 2006 on the public offering of investment instruments and the admission of investment instruments to trading on regulated markets (*Loi relative aux offres publiques d'instruments de placement et aux admissions d'instruments de placement à la négociation sur des marchés réglementés / Wet op de openbare aanbieder van beleggingsinstrumenten en de toelating van beleggingsinstrumenten tot de verhandeling op een gereguleerde markt*) (the "**Prospectus Law**") does not apply to the offer of the Notes issued under the Programme or to the Prospectus. The Prospectus does not constitute a prospectus pursuant to the Prospectus Law implementing the Directive 2003/71/EC of the European Parliament and of the Council of 4 November 2003 on the prospectus to be published when securities are offered to the public or admitted to trading and amending Directive 2001/34/EC (as amended) (the "**Prospectus Directive**") into a Belgian Law. Accordingly, this Prospectus does not purport to meet the format and disclosure requirements of the Prospectus Directive and the Commission Regulation (EC) N° 809/2004 of 29 April 2004 implementing

Directive 2003/71/EC of the European Parliament and of the Council as regards information contained in prospectuses as well as the format, incorporation by reference and publication of such prospectuses and dissemination of advertisements) (as amended) (the "**Prospectus Regulation**"), and it has not been, and will not be, submitted for approval to any competent authority within the meaning of the Prospectus Directive. The Notes issued under the Programme will therefore not qualify for the benefit of the single European passport pursuant to the Prospectus Directive.

DOCUMENTS INCORPORATED BY REFERENCE

This Prospectus should be read and construed in conjunction with any amendments or supplements to this Prospectus, the relevant Pricing Supplement and the budget of the Issuer as annually determined in the Decree of the Walloon Region on the Walloon Region budget for the respective budget year (*Décret contenant le budget des recettes de la Région wallonne pour l'année budgétaire respective*) (the "**Budget**"), which shall be deemed to be incorporated in, and to form part of, this Prospectus and which shall be deemed to modify or supersede the contents of this Prospectus to the extent that a statement contained in any such document is inconsistent with such contents. All documents incorporated by reference in this Prospectus may be obtained, free of charge, at the offices of the Issuer and of the Domiciliary Agent set out at the end of this Prospectus during normal business hours so long as any Notes are outstanding.

OVERVIEW OF THE PROGRAMME

The following overview does not purport to be complete and is taken from, and qualified in its entirety by, the remainder of this Prospectus. The Notes will be issued on such terms as shall be agreed between the Issuer and the Dealer and, unless specified to the contrary in the Pricing Supplement in relation to any such Notes, will be subject to the Terms and Conditions as set out in this Prospectus. Words and expressions defined in "Terms and Conditions of the Notes" (the "**Conditions**") below shall have the same meanings in this overview.

Issuer	Région wallonne
Arranger	BNP Paribas Fortis
Domiciliary Agent	BNP Paribas Fortis
Dealer	BNP Paribas Fortis
Calculation Agent	BNP Paribas Fortis
Description	Programme for the issuance of dematerialised Treasury Notes under Belgian law.
Duration of the Programme	Undetermined, subject to compliance with all relevant laws, regulations and directives. The Programme may be terminated by the Issuer at any time, subject to 60 Business Days (as defined below) prior notice, provided that the Conditions will remain in full force and effect with respect to the then outstanding Treasury Notes.
Programme Limit	<p>Up to EUR 743,500,000 (or the equivalent in any Foreign Currency) in aggregate principal amount of Treasury Notes outstanding at the time of any new issue.</p> <p>When necessary, the face value of the Treasury Notes will be determined by using the latest indicative exchange rate published by the National Bank of Belgium or by the European Central Bank, as applicable.</p>
Currencies	Treasury Notes may be issued in Euro or in any lawful currency of an OECD member state.
Form of Notes	Treasury Notes will be issued in a dematerialised form governed by the Law and the Royal Decree and may not be converted into another form. Ownership of the Treasury Notes will be evidenced by book-entry in the investor's account with the Clearing System or with a direct or indirect participant in the Clearing System.
Types of Notes	Treasury Notes may be non-interest bearing Notes issued on a discount basis (Discount Notes or Zero Coupon Notes) or interest bearing Notes with a fixed rate and/or a floating rate.
Issuance in Series	Treasury Notes will be issued in Series. Each Series may comprise one or more Tranches issued on different issue dates. The Notes of each Series will be subject to identical terms, except that the Issue Date, the Interest Commencement Date and the Issue Price may be different. The Notes of each Tranche will have the same Issue Date.
Pricing Supplement	The terms of the Treasury Notes will be specified in the applicable Pricing Supplement which, for the purposes of the relevant Treasury Notes only, supplements the Conditions set out in the Prospectus. In the event of any inconsistency between the Conditions and the relevant Pricing Supplement, the relevant Pricing Supplement shall prevail. The relevant Pricing Supplement shall be deemed to be part of the Prospectus. Each Noteholder may obtain a copy of the relevant Pricing Supplement at the offices of the Issuer and the Domiciliary Agent as set out at the end of this Prospectus during normal business hours so long as the relevant Notes are outstanding.
Maturity of the Notes	<p>Subject to compliance with all relevant laws, regulations and directives, any maturity between 7 days and 50 years. The Maturity Date will be specified in the relevant Pricing Supplement and as further determined in the Conditions.</p> <ul style="list-style-type: none">▪ "Discount Notes" will designate Treasury Notes with a tenor of maximum one year issued on a discount basis;▪ "Zero Coupon Notes" will designate Treasury Notes with a tenor over one year issued on a discount basis

	<ul style="list-style-type: none"> ▪ "Interest-bearing Notes" will designate Treasury Notes generating periodical interest payments. Interest-bearing Notes will bear interest at a fixed rate and/or at a floating rate by reference to such benchmark and with the relevant duration as can be agreed upon by the Issuer and the investors (via the Dealer) and as indicated in the Pricing Supplement.
Denomination	A minimum amount of EUR 250,000 or its equivalent in any Foreign Currency, or such other denominations as may be determined by the regulations (including the Law and Royal Decree), applicable to the issue of Treasury Notes. However Notes issued to investors which qualify as public administrations (<i>administrations publiques / overheden</i>) pursuant to article 6 of the Royal Decree may be issued with a denomination of minimum EUR 100,000 (or its equivalent in any Foreign Currency).
Early Redemption	Without prejudice to any applicable laws and regulations, the Treasury Notes will not be redeemable at the option of the Issuer, save (i) if specified in the relevant Pricing Supplement; and/or (ii) for taxation reasons, only in the case of Treasury Notes having an original maturity of over one year.
Status of the Notes	The Treasury Notes will constitute direct, unconditional and unsecured obligations of the Issuer and will rank <i>pari passu</i> with all other, present and future, unsecured and unsubordinated obligations of the Issuer, other than creditors preferred by law.
Rating	No ratings have been assigned to the Programme or the Notes to be issued under the Programme.
Other	Negative pledge clause and Cross-default clause are included in the Conditions.
Withholding tax	Provided the Noteholder is a Tax Eligible Holder (as defined below) all payments of principal and interest in respect of the Treasury Notes will be made without withholding or deduction imposed in the Kingdom of Belgium, subject to certain exceptions.
Tax Eligible Investors	Entities referred to in article 4 of the Royal Decree of 26 May 1994, which include, <i>inter alia</i> , Belgian resident companies subject to corporate income tax, Belgian qualifying pension funds in the form of an ASBL/VZW, non-resident corporate investors, non-resident private investors and public sector entities (such as municipalities).
Tax Eligible Holders	Tax Eligible Investors holding the Treasury Notes on an Exempt Account.
Exempt Accounts	Exempt Accounts or X accounts are securities accounts opened in the name of persons or institutions referred to in article 4 of the Royal Decree of 26 May 1994, as amended, which benefit from an exemption from withholding tax.
Non-Exempt Accounts	Non-exempt accounts or N-accounts are securities accounts opened in the name of persons or institutions that do not qualify to hold an X-account, which do not benefit from an exemption from withholding tax.
Clearing System	The securities clearing system (the "Clearing System") recognised or approved in accordance with Articles 3 to 12 of the Law of 2 January 1991, the Law of 6 August 1993 and its implementing decrees as amended, the Law of 15 July 1998 and its implementing decrees and the Law of 2 August 2002, which is currently the X/N securities clearing system operated by the National Bank of Belgium (the "Clearer")
Participants in the Clearing System	Participants in the Clearing System include most Belgian banks and stock brokers, Euroclear, Clearstream, Luxembourg and banks established in a country belonging to the European Community.
Payments	All payments in euro in respect of the Treasury notes will be made through the Domiciliary Agent and the Clearing System in accordance with the Securities Settlement System Regulations and all payments in a currency other than in euro in respect of the Treasury Notes will be made through the Domiciliary Agent and Euroclear and/or Clearstream, Luxembourg.
Issue Method	Each Treasury Note will be issued by sending a Descriptive Card to the Clearer, stating the main features of the Treasury Note, together with the Conditions and the relevant Pricing Supplement. Such Descriptive Card will be prepared or completed by the Domiciliary Agent for the account of and

pursuant to the instructions of the Issuer, in a form agreed between the Issuer, the Clearer and the Domiciliary Agent. The Descriptive Card, the Conditions and the relevant Pricing Supplement will be forwarded to the Clearer by the Domiciliary Agent in conformity with the provisions applicable to the Clearing System and at the latest on the Issue Date.

Selling Restrictions

The offering and sale of the Treasury Notes and the distribution of the present Prospectus are subject to all applicable selling restrictions. See *Selling Restrictions* below.

Secondary Market

Should a Noteholder wish to sell Treasury Notes before their Maturity Date, the Dealer, if requested by a Noteholder to do so, shall use its best efforts to find a buyer for such Treasury Notes, at a price agreed between the Dealer and the Noteholder, without making any commitment to repurchase such Treasury Notes or to find a buyer for such Treasury Notes.

Purchase

The Issuer may at any time purchase Treasury Notes, provided that such purchase is made by the Domiciliary Agent acting for the Issuer and provided that such Treasury Notes are cancelled, without prejudice to the right of the Issuer to issue new Treasury Notes within the limits of the maximum amount of outstanding Treasury Notes under the Programme.

Issue Price

Notes may be issued at any price and either on a fully paid or discounted basis, as specified in the relevant Pricing Supplement.

Listing

The Programme permits Notes to be issued which are unlisted and/or not admitted to trading on any market. The Programme also permits Notes to be issued which are listed or admitted to listing, trading and/or quotation by such listing authorities, stock exchanges and/or quotation systems as may be agreed between the Issuer and the Dealer.

Governing law

The Treasury Notes and any non-contractual obligations arising out of or in connection with the Treasury Notes will be governed by Belgian law.

Inquiries

Any information regarding the Programme may be obtained from the Dealer:

BNP Paribas Fortis
Montagne du Parc, 3
B-1000 BRUSSELS
Attn: Financial Markets - CP Desk
Tel : 32 (0) 2 565 75 30
Fax : 32 (0) 2 565 98 29

TERMS AND CONDITIONS OF THE PROGRAMME

EUR 743,500,000 Multi-currency Treasury Notes Programme

THE FOLLOWING ARE THE TERMS AND CONDITIONS WHICH (SUBJECT TO COMPLETION AND AMENDMENT) WILL BE APPLICABLE TO EACH SERIES OF TREASURY NOTES, PROVIDED THAT THE RELEVANT PRICING SUPPLEMENT IN RELATION TO ANY SUCH TREASURY NOTES MAY SPECIFY OTHER TERMS AND CONDITIONS WHICH SHALL, TO THE EXTENT SO SPECIFIED OR TO THE EXTENT INCONSISTENT WITH THESE TERMS AND CONDITIONS, REPLACE THE FOLLOWING TERMS AND CONDITIONS FOR THE PURPOSE OF SUCH TREASURY NOTES. THE RELEVANT PRICING SUPPLEMENT SHALL BE DEEMED TO BE PART OF THE PROSPECTUS.

1. INTRODUCTION

A. PROGRAMME

The Région wallonne (the "**Issuer**") has established a Multi-currency Treasury Notes Programme (the "**Programme**") for the issuance of "*Billets de Trésorie/Thesauriebewijzen*" (the "**Treasury Notes**" or the "**Notes**").

B. PRICING SUPPLEMENT

Notes issued under the Programme are issued in series (hereinafter each a "**Series**") and each Series may comprise one or more tranches (hereinafter a "**Tranche**") of Notes. Each Tranche will be subject to the terms of a pricing supplement (hereinafter the "**Pricing Supplement**") which supplements these terms and conditions (hereinafter the "**Conditions**"). The terms and conditions applicable to any particular series of Notes are these Conditions as supplemented, amended and/or replaced by the relevant Pricing Supplement. In the event of any inconsistency between these Conditions and the relevant Pricing Supplement, the relevant Pricing Supplement shall prevail. The relevant Pricing Supplement shall be deemed to be part of the Prospectus. If a Tranche is fungible with an existing Series, the Pricing Supplement shall include the reference to that Series and the date on which the Notes become fungible.

C. AGENCY AGREEMENT

The relationship between the Issuer and Fortis Bank NV/SA as domiciliary agent (hereinafter the "**Domiciliary Agent**", which expression includes any successor agent appointed from time to time in connection with the Notes) is determined in accordance an issuing and paying agency agreement entered into on 10 November 1994 as amended, restated or supplemented from time to time (the "**Agency Agreement**"). Copies of the relevant Agency Agreement are available at the offices of the Issuer and of the Domiciliary Agent set out at the end of this Prospectus during normal business hours so long as any Notes are outstanding.

D. CLEARING AGREEMENT

The relationship between the Issuer and the National Bank of Belgium (the "**Clearer**") as operator of the Clearing System (as hereinafter defined) in relation to the clearing of the Notes is governed by a clearing services agreement entered into between the Issuer, the Domiciliary Agent and the Clearer (the "**Clearing Agreement**") and the Securities Settlement Regulations (as hereinafter defined).

E. THE NOTES

All subsequent references in these Conditions to "**Notes**" are to the Notes which are subject to the relevant Pricing Supplement. Copies of the relevant Pricing Supplement are available at the offices of the Issuer and of the Domiciliary Agent set out at the end of this Prospectus during normal business hours so long as the relevant Notes are outstanding.

2. INTERPRETATION AND DEFINITIONS

Definitions: In these Conditions the following expressions have the following meanings:

"**Additional Amount**" shall have the meaning assigned to it in Condition 13;

"**Additional Business Centre(s)**" means the city or cities specified as such in the relevant Pricing Supplement;

"**Agency Agreement**" shall have the meaning assigned to it in Condition 1;

"**Banking, Finance and Insurance Commission**" means the Belgian *Commission bancaire, financière et des assurances / Commissie voor het Bank-, Financie- en Assurantiewezen*;

"**Budget**" shall mean the budget of the Issuer as annually determined in the Decree of the Walloon Region on the Walloon Region budget for the respective budget year (*Décret contenant le budget des recettes de la Région wallonne pour l'année budgétaire respectives*);

"**Business Day**" means any day (other than a Saturday or Sunday) on which banks and the Clearing System are open for business in Brussels and on which banks and foreign exchange markets are generally open for business in each (if any) Additional Business Centre specified in the relevant Pricing Supplement;

"**Cap**" shall have the meaning assigned to it in Condition 9;

"**Calculation Agent**" shall mean the Domiciliary Agent, acting as calculation agent, or any other another bank appointed by the Issuer as calculation agent in accordance with Condition 9;

"**Calculation Amount**" means the Denomination or any other amount specified in the relevant Pricing Supplement;

"**Clearer**" means the National Bank of Belgium;

"**Clearing System**" shall have the meaning assigned to it in Condition 4;

"**Clearstream, Luxembourg**" means Clearstream Banking, société anonyme;

"**Conditions**" shall have the meaning assigned to it in Condition 1;

"**Custodian**" shall have the meaning assigned to it in Condition 3;

"**Day Count Fraction**" means, in respect of the calculation of an amount of interest on any Note for any period of time (from and including the first day of such period to but excluding the last) (whether or not constituting an Interest Period or an Interest Accrual Period, the "**Calculation Period**") such day count fraction as may be specified in these Conditions or the relevant Pricing Supplement and:

(i) if "**Actual/Actual**" is so specified means, the actual number of days in the Calculation Period divided by 365 (or, if any portion of the Calculation Period falls in a leap year, the sum of (A) the actual number of days in that portion of the Calculation Period falling in a leap year divided by 366 and (B) the actual number of days in that portion of the Calculation Period falling in a non-leap year divided by 365);

(i) if "**Actual/Actual (ICMA)**" is so specified, means:

(A) where the Calculation Period is equal to or shorter than the Regular Period during which it falls, the actual number of days in the Calculation Period divided by the product of (1) the actual number of days in such Regular Period and (2) the number of Regular Periods in any year; and

(B) where the Calculation Period is longer than one Regular Period, the sum of:

(1) the actual number of days in such Calculation Period falling in the Regular Period in which it begins divided by the product of (1) the actual number of days in such Regular Period and (2) the number of Regular Periods in any year; and

(2) the actual number of days in such Calculation Period falling in the next Regular Period divided by the product of (a) the actual number of days in such Regular Period and (2) the number of Regular Periods in any year;

(ii) if "**Actual/360**" is so specified means, the actual number of days in the Calculation Period divided by 360;

(iii) if "**Actual/365 (Fixed)**" is so specified means, the actual number of days in the Calculation Period divided by 365;

(iv) if "**30/360**", "**360/360**" or "**Bond Basis**" is so specified means, the number of days in the Calculation Period divided by 360, calculated on a formula basis as follows:

$$\text{Day Count Fraction} = \frac{[360 \times (Y_2 - Y_1)] + [30 \times (M_2 - M_1)] + (D_2 - D_1)}{360}$$

"Y1" is the year, expressed as a number, in which the first day of the Calculation Period falls;

"Y2" is the year, expressed as a number, in which the day immediately following the last day included in the Calculation Period falls;

"M1" is the calendar month, expressed as a number, in which the first day of the Calculation Period falls;

"M2" is the calendar month, expressed as a number, in which the day immediately following the last day included in the Calculation Period falls;

"D1" is the first calendar day, expressed as a number, of the Calculation Period, unless such number would be 31, in which case D1 will be 30; and

"D2" is the calendar day, expressed as a number, immediately following the last day included in the Calculation Period, unless such number would be 31 and D1 is greater than 29, in which case D2 will be 30

(v) if "**30E/360**" or "**Eurobond Basis**" is so specified means, the number of days in the Calculation Period divided by 360 calculated on a formula basis as follows:

$$\text{Day Count Fraction} = \frac{[360 \times (Y_2 - Y_1)] + [30 \times (M_2 - M_1)] + (D_2 - D_1)}{360}$$

where:

"Y1" is the year, expressed as a number, in which the first day of the Calculation Period falls;

"Y2" is the year, expressed as a number, in which the day immediately following the last day included in the Calculation Period falls;

"M1" is the calendar month, expressed as a number, in which the first day of the Calculation Period falls;

"M2" is the calendar month, expressed as a number, in which the day immediately following the last day included in the Calculation Period falls;

"D1" is the first calendar day, expressed as a number, of the Calculation Period, unless such number would be 31, in which case D1 will be 30; and

"D2" is the calendar day, expressed as a number, immediately following the last day included in the Calculation Period, unless such number would be 31, in which case D2 will be 30; and

"**Denomination**" shall have the meaning given to it in the relevant Pricing Supplement and shall be a minimum amount of EUR 250,000 or its equivalent in any Foreign Currency, or such other denominations as may be determined by the regulations (including the Law and Royal Decree), applicable to the issue of Treasury Notes, it being understood that Notes issued to investors which qualify as public administrations (*administrations publiques / overheden*) pursuant to article 6 of the Royal Decree may be issued with a denomination of minimum EUR 100,000 (or its equivalent in any Foreign Currency);

"**Descriptive Card**" shall have the meaning assigned to it in Condition 3;

"**Euro**" or ("**EUR**") refers to the lawful currency of the participating member states of the European Union that adopt a single currency in accordance with the Treaty establishing the European Community as amended by the Treaty on European Union;

"**Euroclear**" means Euroclear Bank S.A./N.V.;

"**Eurozone**" means the region comprising the member states of the European Union which adopt or have adopted the euro as their lawful currency in accordance with the Treaty establishing the European Community as amended by the Treaty on the European Union;

"**Extraordinary Resolution**" shall have the meaning assigned to it in the Agency Agreement;

"**Face Value**" has the meaning assigned to it in Condition 10;

"**Fixed Rate Notes**" shall mean the Notes referred to under Condition 9 (A) 1°;

"**Fixed to Floating Rate Notes**" shall mean the Notes referred to under Condition 9 (A) 3°;

"**Floating Rate Notes**" shall mean the Notes referred to under Condition 9 (A) 2°;

"**Floating to Fixed Rate Notes**" shall mean the Notes referred to under Condition 9 (A) 3°

"**Floor**" shall have the meaning assigned to it in Condition 9;

"**Foreign Currency**" refers to the lawful currency of an OECD member state other than Euro;

"**Interest Accrual Period**" means the period beginning on (and including) the Interest Commencement Date and ending on (but excluding) the first Interest Period Date and each successive period beginning on (and including) an Interest Period Date and ending on (but excluding) the next Interest Period Date;

"**Interest Amount**" means (i) in respect of an Interest Accrual Period, the amount of interest payable per Calculation Amount for that Interest Accrual Period and (ii) in respect of any other period, the amount of interest payable per Calculation Amount for that period;

"**Interest Commencement Date**" means the Issue Date of the Notes or such other date as may be specified as the Interest Commencement Date in the relevant Pricing Supplement;

"**Interest Determination Date**" has the meaning given in the relevant Pricing Supplement, or if none is so specified, (i) the day falling two TARGET Settlement Days prior to the first day of such Interest Accrual Period if the currency of the Notes is in euro or (ii) the day falling two Business Days in London for the relevant currency prior to the first day of such Interest Accrual Period if the currency is neither sterling nor euro or (iii) the first day of such Interest Accrual Period if the currency is sterling;

"**Interest Payment Date**" shall have the meaning assigned to it in Condition 9;

"**Interest Period**" means the period beginning on (and including) the Interest Commencement Date and ending on (but excluding) the first Interest Payment Date and each successive period beginning on (and including) an Interest Payment Date and ending on (but excluding) the next succeeding Interest Payment Date;

"**Interest Period Date**" means each Interest Payment Date unless otherwise specified in the relevant Pricing Supplement;

"**Interest Rate**" shall have the meaning assigned to it in Condition 9;

"**Issue Date**" shall have the meaning assigned to it in Condition 8;

"**Law**" means the Law of 22 July 1991 on treasury notes and certificates of deposit (*Loi relative aux billets de trésorerie et aux certificats de dépôt / Wet betreffende de thesauriebewijzen en de depositobewijzen*) (as amended);

"**Law of 2 January 1991**" means the Law of 2 January 1991 on the market of public debt securities and the monetary policy instruments (*Loi relative au marché des titres de la dette publique et aux instruments de la politique monétaire / Wet betreffende de markt van de effecten van de overheidsschuld en het monetair beleidsinstrumentarium*) (as amended);

"**Law of 6 August 1993**" means the Law of 6 August 1993 regarding certain securities transactions (*Loi relative aux opérations sur certains valeurs mobilières / Wet betreffende de transacties met bepaalde effecten*) (as amended);

"**Law of 15 July 1998**" means the Law of 15 July 1998 regarding the amendment of certain legal provisions on financial instruments and securities clearing systems (*Loi modifiant diverses dispositions légales en matière d'instruments financiers et de système de compensation de titres / Wet tot wijziging van sommige wettelijke bepalingen inzake financiële instrumenten en effecten clearingstelsels*) (as amended);

"Law of 2 August 2002" means the Law of 2 August 2002 on supervision of the financial industry and financial services (*Loi relative à la surveillance du secteur financier et aux services financiers / Wet betreffende het toezicht op de financiële sector en de financiële diensten*) (as amended);

"Maturity Date" shall have the meaning assigned to it in Condition 10;

"Multiplier" shall have the meaning assigned to it in Condition 9;

"Persons" means any individual, company, corporation, firm, partnership, joint venture, association, organisation, state or agency of a state or other entity, whether or not having separate legal personality;

"Pricing Supplement" shall have the meaning assigned to it in Condition 1;

"Prospectus Directive" means Directive 2003/71/EC of the European Parliament and of the Council of 4 November 2003 on the prospectus to be published when securities are offered to the public or admitted to trading and amending Directive 2001/34/EC (as amended);

"Prospectus Law" means the Law of 16 June 2006 on the public offering of investment instruments and the admission of investment instruments to trading on regulated markets (*Loi relative aux offres publiques d'instruments de placement et aux admissions d'instruments de placement à la négociation sur des marchés réglementés / Wet op de openbare aanbieder van beleggingsinstrumenten en de toelating van beleggingsinstrumenten tot de verhandeling op een gereguleerde markt*);

"Prospectus Regulation" means Commission Regulation (EC) N° 809/2004 of 29 April 2004 implementing Directive 2003/71/EC of the European Parliament and of the Council as regards information contained in prospectuses as well as the format, incorporation by reference and publication of such prospectuses and dissemination of advertisements) (as amended);

"Reference Banks" means the four major banks selected by the Calculation Agent in the market that is, according to the Calculation Agent, most closely connected with the Reference Rate;

"Reference Rate" shall have the meaning assigned to it in Condition 9;

"Regular Period" means:

(i) in the case of Notes where interest is scheduled to be paid only by means of regular payments, each period from and including the Interest Commencement Date to but excluding the first Interest Payment Date and each successive period from and including one Interest Payment Date to but excluding the next Interest Payment Date;

(ii) in the case of Notes where, apart from the first Interest Period, interest is scheduled to be paid only by means of regular payments, each period from and including a Regular Date falling in any year to but excluding the next Regular Date, where Regular Date means the day and month (but not the year) on which any Interest Payment Date falls; and

(iii) in the case of Notes where, apart from one Interest Period other than the first Interest Period, interest is scheduled to be paid only by means of regular payments, each period from and including a Regular Date falling in any year to but excluding the next Regular Date, where Regular Date means the day and month (but not the year) on which any Interest Payment Date falls other than the Interest Payment Date falling at the end of the irregular Interest Period;

"Relevant Financial Centre" means London, plus the Eurozone in the case of Treasury Notes denominated in euro, or such other financial center as may be specified in the relevant Pricing Supplement;

"Relevant Screen Page" means the page, section or other part of a particular information service specified as the Relevant Screen Page in the relevant Pricing Supplement, or such other page, section or other part as may replace it on that information service or such other information service, in each case, as may be nominated by the Person providing or sponsoring the information appearing there for the purpose of displaying rates or prices comparable to the Reference Rate;

"Relevant Time" has the meaning given in the relevant Pricing Supplement;

"Reserved Matter" means any proposal:

(i) to change any date fixed for payment of principal or interest in respect of the Notes, to reduce the amount of principal or interest payable on any date in respect of the Notes or to alter the method of calculating the amount of any payment in respect of the Notes on redemption or maturity or the date for any such payment;

(ii) to change the currency in which amounts due in respect of the Notes are payable;

(iii) to change the quorum required at any meeting or the majority required to pass an Extraordinary Resolution; or

(iv) to amend this definition;

"Royal Decree" means the Royal Decree of 14 October 1991 on treasury notes and certificates of deposit (*Arrêté royal relatif aux billets de trésorerie et aux certificats de dépôt / Koninklijk Besluit betreffende de thesauriebewijzen en de depositobewijzen*) (as amended);

"Royal Decree of 26 May 1994" means the Royal Decree of 26 May 1994 regarding the withholding and compensation of withholding tax in accordance with chapter I of the Law of 6 August 1993 regarding certain securities transactions (*Arrêté royal relative à la perception et à la bonification du précompte mobilier conformément au chapitre Ier de la loi du 6 août 1993 relative aux opérations sur certaines valeurs mobilières / Koninklijk besluit over de inhouding en de vergoeding van de roerende voorheffing overeenkomstig hoofdstuk I van de wet van 6 augustus 1993 betreffende de transacties met bepaalde effecten*) (as amended);

"**Royal Decree of 14 June 1994**" means the Royal Decree of 14 June 1994 regarding the recognition of a clearing system for the purposes of the implementation of Chapter I of the Law of 6 August 1993 regarding certain securities transactions (*Arrêté royal portant agrément d'un système de liquidation pour la mise en oeuvre du chapitre Ier de la loi du 6 août 1993 relative aux opérations sur certaines valeurs mobilières / Koninklijk besluit houdende erkenning van een vereffeningstelsel met het oog op de inwerkingstelling van hoofdstuk I van de wet van 6 augustus 1993 betreffende de transacties met bepaalde effecten*) (as amended);

"**Securities Settlement System Regulations**" means the rules and regulations applicable to the Clearing System from time to time;

"**Series**" shall have the meaning assigned to it in Condition 1;

"**Specified Currency**" has the meaning given in the relevant Pricing Supplement;

"**TARGET2**" means the Trans-European Automated Real-Time Gross Settlement Express Transfer payment system which utilises a single shared platform and which was launched on 19 November 2007;

"**TARGET Settlement Day**" means any day on which TARGET2 is open for the settlements of payment in euro;

"**Tax**" shall have the meaning assigned to it in Condition 13;

"**Tax Deduction**" shall have the meaning assigned to it in Condition 13; and

"**Tranche**" shall have the meaning assigned to it in Condition 1.

3. FORM OF THE TREASURY NOTES

Treasury Notes are issued under the form of dematerialised treasury notes (*billets de trésorie/thesauriebewijzen*) in accordance with the Law and the Royal Decree.

Treasury Notes will be issued in any Denominations agreed between the Issuer and the relevant Dealer, subject to compliance with all applicable legal and/or securities settlement systems and/or regulatory and/or central bank requirements.

Each Treasury Note will be issued by sending to the Clearer a document called "*Descriptive Card Billets de Trésorie/Thesauriebewijzen*" (the "**Descriptive Card**"), stating the main features of the Treasury Note, together with the Conditions and the relevant Pricing Supplement. Such Descriptive Card will be prepared or completed by the Domiciliary Agent for the account of and pursuant to the instructions of the Issuer, in a form agreed between the Issuer, the Clearer and the Domiciliary Agent. The Descriptive Card, the Conditions and the relevant Pricing Supplement will be forwarded to the Clearer by the Domiciliary Agent in conformity with the provisions applicable to the Clearing System and at the latest on the Issue Date.

Treasury Notes issued under this Programme will be in a dematerialised form only and may not be converted into another form. Ownership of the Treasury Notes will be evidenced by book-entry in the investor's account with the Clearer or with a direct or indirect participant in the Clearing System, classified under "X/N" accounts as determined by the Law of 6 August 1993 and the Royal Decrees of 26 May 1994 and 14 June 1994.

In these Conditions, reference to a "**Noteholder**" will be to the owner of such Treasury Note as shown by the book-entry in respect of such Treasury Note, and reference to a "**Custodian**" will be to a direct or indirect participant in the Clearing System with whom a Noteholder may have a securities account in which its ownership of Treasury Notes is evidenced by book-entry.

4. CLEARING SYSTEM

The Treasury Notes shall be issued and settled, and interest payments on or payments in redemption of the Treasury Notes shall be made through the securities clearing system (the "**Clearing System**") recognised or approved in accordance with Articles 3 to 12 of the Law of 2 January 1991, the Law of 6 August 1993 and its implementing decrees as amended, the Law of 15 July 1998 and its implementing decrees and the Law of 2 August 2002, which is currently the X/N securities clearing system operated by the Clearer")

Reference is made to the Clearing Agreement (see below "Description of the Belgian Clearing System"). For Treasury Notes denominated in a Foreign Currency, reference is made to the Royal Decree of 14 June 1994, regarding the rules applicable to Treasury Notes denominated in currencies other than euro.

5. CURRENCY

Treasury Notes may be issued in Euro or in any other Foreign Currency.

6. STATUS OF THE TREASURY NOTES

Treasury Notes issued under the Programme will be direct, unconditional and unsecured obligations of the Issuer and will rank *pari passu* with all other, present and future, unsecured and unsubordinated obligations of the Issuer, other than creditors preferred by law.

7. NEGATIVE PLEDGE

So long as any of the Treasury Notes remains outstanding, the Issuer shall not create or permit to exist any mortgage, lien (other than liens arising by operation of law), pledge, charge or other security interest upon the whole or any part of its present or future assets or revenues to secure any indebtedness which is in the form of, or represented or evidenced by, bonds, notes, debentures, loan stock or other securities which for the time being are, or are intended to be or capable of being, quoted, listed or dealt in or traded on any stock exchange or over-the-counter or other securities market unless the benefit of such mortgage, lien, pledge, charge or other security interest shall be extended forthwith equally and rateably to the Treasury Notes issued under this Programme.

8. ISSUE PRICE

A. NON-INTEREST BEARING NOTES

Non-interest bearing Notes will be issued on a discount basis, for which the implicit rate will be the interest rate mentioned in the relevant Pricing Supplement. In such case, the issue price paid to the Issuer on the date on which a Treasury Note is purchased from the Issuer (the "Issue Date") shall be calculated as follows :

1° Discount Notes (Treasury Notes having a maturity up to 1 year)

$$IP = \frac{FV}{1 + \left(\frac{D \times Y}{C} \right)}$$

where :

- IP** = Issue price of the Treasury Note;
- FV** = Face Value of the Treasury Note to be redeemed on the Maturity Date;
- Y** = Implicit rate of the Treasury Note expressed as an annual rate per annum divided by 100;
- D** = The actual number of days in the period from and including the Issue Date to, but excluding, the Maturity Date;
- C** = 365 or 360, or following market practices, as specified in the relevant Pricing Supplement.

2° Zero coupon Notes (Treasury Notes having a maturity over 1 year)

$$IP = \frac{FV}{\left(1 + Y \right)^{\frac{D}{C}}}$$

where :

- IP** = Issue price of the Treasury Note;
- FV** = Face Value of the Treasury Note to be redeemed on the Maturity Date;
- Y** = Implicit rate of the Treasury Note expressed as an annual rate per annum divided by 100;
- D** = The actual number of days in the period from and including the Issue Date to, but excluding, the Maturity Date, or such other number as may be determined as being the number of days during the same period based on the market practice for the relevant currency at the time of issue of the relevant Treasury Note;
- C** = Actual number of days in a year or such other basis that may be market practice for the relevant currency at the time of issue of the Treasury Note, and as specified in the relevant Pricing Supplement.

B. INTEREST-BEARING NOTES

Interest-bearing Notes will be issued at a price, plus accrued interest (in the case of fungible issues only, if applicable), that will be determined in the relevant Pricing Supplement.

9. INTEREST AMOUNTS

A. INTEREST RATE

Each interest-bearing Note bears interest at a rate per annum (expressed as a percentage) (the "Interest Rate") that will be determined as follows :

1° Fixed Rate Notes

The Interest Rates will be determined in the Pricing Supplement. If so specified in the relevant Pricing Supplement, a different Interest Rate can be applied in respect of each different Interest Period.

2° Floating Rate Notes

For each Interest Period, the reference rate (the "**Reference Rate**") will be determined by the Domiciliary Agent acting as Calculation Agent of the Issuer and not as agent of the Noteholders, following the information provided for in the relevant Pricing Supplement, by determining the relevant Reference Rate for the duration specified in the Pricing Supplement, using the Relevant Screen Page, and (i) by adding or subtracting, as the case may be, to such Reference Rate the margin determined in the Pricing Supplement (the "**Margin**"), (ii) by multiplying, as the case may be, to such Reference Rate the multiplier determined in the Pricing Supplement (the "**Multiplier**"), and (iii) by applying, as the case may be, to the resulting rate the maximum rate (or cap) as determined in the Pricing Supplement (the "**Cap**") and/or the minimum rate (or floor) as determined in the Pricing Supplement (the "**Floor**").

- (i) If the Reference Rate is a composite quotation or customarily supplied by one entity, the Calculation Agent will determine the Reference Rate which appears on the Relevant Screen Page as of the Relevant Time on the relevant Interest Determination Date;
- (ii) In any other case, the Calculation Agent will determine the arithmetic mean of the Reference Rates which appear on the Relevant Screen Page as of the Relevant Time on the relevant Interest Determination Date;
- (iii) If, in the case of (i) above, such rate does not appear on that page or, in the case of (ii) above, fewer than two such rates appear on that page or if, in either case, the Relevant Screen Page is unavailable, the Calculation Agent will, as soon as practicable:
 - (A) request the principal Relevant Financial Centre office of each of the Reference Banks to provide a quotation of the Reference Rate at approximately the Relevant Time on the Interest Determination Date to prime banks in the Relevant Financial Centre interbank market in an amount that is representative for a single transaction in that market at that time; and
 - (B) determine the arithmetic mean of such quotations; and
- (iv) if fewer than two such quotations are provided as requested, the Calculation Agent will determine the Reference Rate, as soon as practicable, in its sole discretion and acting in good faith.

3° Fixed to Floating Rate Notes and Floating to Fixed Rate Notes

If so specified by the relevant Pricing Supplement, Notes may be issued whereby (i) for certain Interest Periods a fixed Interest Rate (as determined in the Pricing Supplement) will be applied and (ii) for certain subsequent Interest Periods a floating rate (as determined in accordance with the provisions on Floating Rate Notes as set out above and as set out in the relevant Pricing Supplement) will be applied (**Fixed to Floating Rate Notes**). The changes of interest basis may be determined in advance (i.e. rate(s) and date(s)), or may be subject to conditions as mentioned in the relevant Pricing Supplement but in this case the relevant Interest Rate shall be determined at the latest on the first day of each relevant Interest Period.

If so specified by the relevant Pricing Supplement, Notes may be issued whereby (i) for certain Interest Periods a floating rate (as determined in accordance with the provisions on Floating Rate Notes as set out above and as set out in the relevant Pricing Supplement) will be applied and (ii) for certain subsequent Interest Periods a fixed Interest Rate will be applied (**Floating to Fixed Rate Notes**). The changes of interest basis may be determined in advance (i.e. rate(s) and date(s)), or may be subject to conditions as mentioned in the relevant Pricing Supplement but in this case the relevant Interest Rate shall be determined at the latest on the first day of each relevant Interest Period.

B. ACCRUAL

Each Fixed Rate Note and Floating Rate Note bears interest on its outstanding nominal amount from the Interest Commencement Date at the rate per annum (expressed as a percentage) equal to the Interest Rate, such interest being payable in arrear on each Interest Payment Date. The amount of interest payable shall be determined in accordance with Condition 9, D.

C. BUSINESS DAY CONVENTION

If any date referred to in these Conditions (or the relevant Pricing Supplement) that is specified to be subject to adjustment in accordance with a Business Day Convention would otherwise fall on a day which is not a Business Day, then, if the Business Day Convention specified in the relevant Pricing Supplement is (i) the Floating Rate Business Day Convention, such date shall be postponed to the next day which is a Business Day unless it would thereby fall into the next calendar month, in which event (A) such date shall be brought forward to the immediately preceding Business Day and (B) each subsequent such date shall be the last Business Day of the month in which such date would have fallen had it not been subject to adjustment, (ii) the Following Business Day Convention, such date shall be postponed to the next day which is a Business Day, (iii) the Modified Following Business Day Convention, such date shall be postponed to the next day which is a Business Day unless it would thereby fall into the next calendar month, in which event such date shall be brought forward

to the immediately preceding Business Day or (iv) the Preceding Business Day Convention, such date shall be brought forward to the immediately preceding Business Day.

D. CALCULATIONS

The amount of interest payable per Calculation Amount in respect of any Note for any Interest Accrual Period shall be equal to the product of the Interest Rate, the Calculation Amount specified hereon, and the Day Count Fraction for such Interest Accrual Period, in which case the amount of interest per Calculation Amount in respect of such Note for such Interest Accrual Period shall equal such Interest Amount (or be calculated in accordance with such formula). Where an Interest Period comprises two or more Interest Accrual Periods, the amount of interest payable per Calculation Amount in respect of such Interest Period shall be the sum of the Interest Amounts payable in respect of each such Interest Accrual Periods. In respect of any other period for which interest is required to be calculated, the provisions above shall apply save that the Day Count Fraction shall be for the period for which interest is required to be calculated.

For the purposes of any calculations required pursuant to these Conditions (unless otherwise specified), (x) all percentages resulting from such calculations shall be rounded, if necessary, to the nearest one hundred-thousandth of a percentage point (with halves being rounded up), (y) all figures shall be rounded to seven significant figures (with halves being rounded up) and (z) all currency amounts shall be rounded to the nearest unit of such currency (with halves being rounded up), save in the case of yen, which shall be rounded down to the nearest yen. For these purposes "unit" means the lowest amount of such currency that is available as legal tender in the country(ies) of such currency.

E. CALCULATIONS BY THE DOMICILIARY AGENT

The Domiciliary Agent and the Issuer will have no responsibility for good faith errors or omissions in any calculations made or provided by the Domiciliary Agent. The calculations and determinations of the Domiciliary Agent will be made in accordance with the Conditions and the relevant Pricing Supplement having regards, in each case, to the relevant criteria stipulated in the Conditions and in the relevant Pricing Supplement, and, where relevant, on the basis of information provided to or obtained by it as well as after such further enquiries as it deems necessary. Such calculations will, in the absence of manifest error, be final, conclusive and binding on the holders of Notes.

If the Domiciliary Agent is unable or unwilling to act as calculation agent or if the Domiciliary Agent fails duly to establish the Interest Rate for any Interest Period or to calculate the amount of interest for an Interest Period, the Issuer will appoint another leading bank engaged in the interbank market to act as such in its place and make the relevant determination(s).

10. REDEMPTION OF THE TREASURY NOTES

A. FINAL REDEMPTION

The Treasury Notes will be redeemed at their Face Value (or any other amount specified in the relevant Pricing Supplement) on the day on which such Treasury Notes become due and payable pursuant to the terms thereof as specified in the relevant Pricing Supplement (the "Maturity Date") (it being understood that the Maturity Date is subject to adjustment in accordance with a Business Day Convention, as specified in the relevant Pricing Supplement) subject to the redemption or cancellation of the Treasury Notes prior to their Maturity Date as contemplated hereafter and in Condition 14.

In these terms and conditions, "Face Value" means (i) for Discount Notes and Zero Coupon Notes, the par value of such Treasury Note, exclusive of premium, payable by Issuer at the Maturity Date of such Treasury Note, and (ii) for Interest-bearing Notes, the principal amount of such Treasury Note, exclusive of premium or interest, payable by the Issuer at the Maturity Date of such Treasury Note.

B. PURCHASE OF TREASURY NOTES BY THE ISSUER.

The Issuer may at any time purchase Treasury Notes, provided that such purchase is made by the Domiciliary Agent acting for the Issuer and provided that such Treasury Notes are cancelled, without prejudice to the right of the Issuer to issue new Treasury Notes within the limits of the maximum amount of outstanding Treasury Notes under the Programme.

C. REDEMPTION AT THE OPTION OF THE ISSUER

If so specified in the relevant Pricing Supplement, the Issuer will have the right (but not the obligation) to early redeem all, but not part of, the Notes of a Tranche, on giving not more than 30 and not less than 15 days' notice to the Noteholders (which notice shall be irrevocable) in accordance with Condition 17 (or such other notice period as may be specified in the relevant Pricing Supplement),

(i) at a redemption amount per Note being equal to,

(a) for interest bearing Notes, the Face Value of the Note increased with any accrued interest,

(b) for non-interest bearing Notes, the discounted amount calculated based on the Issue Date and the effective redemption date resulting from the application of the formula contained in Condition 8, A, 1° or 8, A, 2° (as applicable), with "IP" as the redemption amount and "D" as the number of days between the date on which the Treasury Note becomes due and payable and the original Maturity Date of such Treasury Note, or

- (c) at any other redemption amount specified in the relevant Pricing Supplement, and
(ii) on the early redemption date(s) specified in the relevant Pricing Supplement.

D. EARLY REDEMPTION FOR TAX REASONS

Treasury Notes having an original maturity of over one year may be redeemed at the option of the Issuer (which shall be under no obligation to do so) in whole, but not in part, at any time (or only on dates as may be specified in the relevant Pricing Supplement) on giving not more than 30 and not less than 15 days' notice (or such other notice period as may be specified in the relevant Pricing Supplement, but with a minimum of 10 days) to the Noteholders (which notice shall be irrevocable) in accordance with Condition 17, if on the next Interest Payment Date the Issuer, the Clearer, the Domiciliary Agent or any other person would be required to make a Tax Deduction (as defined in Condition 13) from any payment of principal or interest in respect of Notes held by or on behalf of any Noteholder who would, but for any amendment to, or change in, the tax laws or regulations of the Kingdom of Belgium (or any sub-division or authority thereof or therein having power to tax) or in the interpretation by a revenue authority or a court of, or in the administration of, such laws or regulations after the issue date of the Notes, have been a Tax Eligible Holder. The right of the Issuer to early redeem the Notes pursuant to this Condition 8 D shall not apply if the said amendment to, or change in, the tax laws or regulations or in the interpretation by a revenue authority or a court of, or in the administration of, such laws or regulations, is decided or caused by the Issuer.

Such redemption will take place for an amount per Treasury Note equal to: (i) in the case of Non-interest bearing Notes, the result of the formula contained in Condition 8. A., 2°, with "IP" as the redemption amount and "D" as the number of days between the date on which the Treasury Note becomes due and payable and the original Maturity Date of such Treasury Note; and (ii) in the case of Interest-bearing Notes, the Face Value of the Treasury Note increased by the accrued interest thereon, if any.

Prior to the aforementioned notice, the Issuer shall deliver to the Domiciliary Agent a certificate signed by two directors of the Issuer stating that the Issuer is entitled to perform such redemption and setting forth a statement of the facts which demonstrates that the conditions for such redemption are fulfilled.

11. PAYMENTS

All payments will be made by the credit of the account of the Noteholder or of the Custodian, as the case may be, with the Clearer. In the case of payment of principal, such payment will be made against the debit of the relevant Treasury Notes on the securities account of the Noteholder with the Custodian.

If any date for payments in respect of any Treasury Note is not a Business Day, the Noteholder shall not be entitled to payment until the next following Business Day or to any interest or other sum in respect of such postponed payment.

Any amount remaining unpaid on the due date, shall, to the extent permitted by law, incur interest ipso jure and without previous notice, until the actual payment of all amounts due, at a rate that will be 1 % per annum over :

- (i) the implicit rate of the Treasury Note, in the case of a Discount Note or a Zero Coupon Note;
- (ii) the applicable rate, in case of a Fixed Rate Note; and;
- (iii) the Interest Rate applicable to the last Interest Period, in case of Floating Rate Notes.

Such interest will not be calculated on a compound basis.

12. SELLING RESTRICTIONS

Without prejudice to the Selling Restrictions annexed to this Prospectus, Treasury Notes will only be sold to investors keeping the purchased Treasury Notes on a securities account opened with the Clearer or with a Custodian and Zero-coupon Notes having an original maturity over one year may only be offered or sold to purchasers that are holding such Treasury Notes on an X-account.

13. TAXATION

The following provides general information on certain Belgian tax aspects in relation to the Treasury Notes, as of the date hereof. It is not exhaustive and (prospective) Noteholders are urged to consult their own tax advisers.

As a general rule, the Noteholders will bear any present or future tax, duty or charge of whatever nature levied by, or on behalf of the Kingdom of Belgium, or any political subdivision thereof or any authority or agency therein or thereof having power to tax ("Tax"), which may arise from the purchase, holding, redemption and/or disposal of Treasury Notes.

Provided that the Noteholder has delivered to its Custodian a certificate evidencing that it is a Tax Eligible Investor and that the Notes have been booked on a fully qualifying Exempt Account, in accordance with the Law of 6 August 1993, the Royal Decree of 26 May 1994 and the derivative rules as amended from time to time, all payments of principal and interest by the Issuer in respect of the Treasury Notes will be made without any

withholding or deduction for, or on account of, Tax (a "**Tax Deduction**"), unless a Tax Deduction is required by law.

In the case of a Tax Deduction, the Issuer will pay such additional amount (the "**Additional Amount**") as may be necessary for the net amounts received by the Treasury Noteholders after such Tax Deduction to equal the respective amounts which would have been received by the Noteholders in the absence of such Tax Deduction.

No Additional Amounts shall be payable with respect to any Treasury Note to, or to a third party on behalf of, any Noteholder:

- (a) if the Tax Deduction is a result of the Noteholder's own failure to hold the Note in an X-account in accordance with the Law of 6 August 1993, the Royal Decree of 26 May 1994 and the derivative rules as amended from time to time, or of its own infringement of this legislation;
- (b) if the Tax Deduction in respect of such Treasury Note is due to the Noteholder having some connection with the Kingdom of Belgium other than (i) the mere holding of such Treasury Note or (ii) the receipt of any payments in respect of such Treasury Note; or
- (c) if the Tax Deduction in respect of such Treasury Note is due to the Noteholder not having fulfilled certain formalities or not having made a declaration of non-residence or other similar claim for exemption to the relevant tax authority.

If the Noteholder holds the Treasury Notes on an account which is designated in the Clearing System as a N-account in accordance with the Royal Decree of 26 May 1994, all payments of principal and interest in respect of the Treasury Notes by the Issuer will, subject to applicable law, be made after a Tax Deduction by the Clearer or the Domiciliary Agent, as appropriate (see hereafter "Description of the Belgian Clearing System")

For the avoidance of doubt, no Additional Amount will be payable by the Issuer in such case.

Pursuant to Article 126-1-9° of the Code on Miscellaneous Duties and Taxes (*Code des droits et taxes divers / Wetboek diverse rechten en taksen*), no tax on Stock Exchange Transactions (*taxe sur les opérations de bourse / taks op beursverrichtingen*) applies on transactions involving Treasury Notes in Belgium.

14. EVENTS OF DEFAULT

If any of the following events occurs and is continuing :

- (A) default in the payment of principal or interest in respect of the Treasury Notes and such default shall have continued for a period of 15 days;
- (B) default by the Issuer in the due performance or observance of any other obligation or provision under or in relation to the Treasury Notes, if such default is not cured within 30 days after receipt by the Issuer of notice by a Noteholder requiring the default to be cured;
- (C) default by the Issuer in the payment of any amount in respect of any other loan indebtedness of or assumed or guaranteed by the Issuer (which indebtedness has an aggregate principal amount of at least EUR 15,000,000 or its equivalent in any other currency), when and as the same shall become due and payable, if such default shall continue for more than the period of grace, if any, originally applicable thereto and the time for payment has not been extended, or in the event that any such loan indebtedness shall have become repayable before the due date thereof as a result of acceleration of maturity caused by the occurrence of an event of default thereunder;
- (D) any representation, warranty or statement made by the Issuer in connection with the Prospectus or the Treasury Notes is proved to have been incorrect in any material respect;
- (E) the Issuer is unable to, or admits its inability to, pay any indebtedness, or shall declare a moratorium on or readjustment of any such indebtedness;
- (F) it becomes unlawful for the Issuer to perform any of its obligations under the Treasury Notes or any of its obligations ceases to be valid, binding or enforceable;

then the Noteholder may give written notice to the Issuer or to the Agent that such Treasury Note is immediately repayable, whereupon, unless prior to the date of such notice the Issuer has cured all Events of Default in respect of the Treasury Notes, such Treasury Notes shall become immediately due and payable for an amount per Treasury Note equal to: (i) in the case of Non-interest bearing Notes, the result of the formula contained in Condition 8. A. 1° or 2° (as applicable), with "IP" as the redemption amount and "D" as the number of days between the date on which the Treasury Note becomes due and payable and the original Maturity Date of such Treasury Note, and (ii) in the case of Interest-bearing Notes, the Face Value of the Treasury Note increased by accrued interest thereon, if any.

15. MEETINGS OF NOTEHOLDERS

A. MEETINGS OF NOTEHOLDERS

The Agency Agreement contains provisions for convening meetings of Noteholders to consider matters relating to the Notes, including the modification of any provision of these Conditions. Any such modification may be made if sanctioned by an Extraordinary Resolution. Such a meeting may be convened by the Issuer and shall be convened by it upon the request in writing of Noteholders holding not less than one-tenth of the aggregate principal amount of the outstanding Notes. The quorum at any meeting convened to vote on an Extraordinary Resolution will be one or more Persons holding or representing more than half of the aggregate principal amount of the outstanding Notes or, at any adjourned meeting, two or more Persons being or representing Noteholders whatever the principal amount of the Notes held or represented; provided, however, that Reserved Matters may only be sanctioned by an Extraordinary Resolution passed at a meeting of Noteholders at which two or more Persons holding or representing not less than three-quarters or, at any adjourned meeting, one quarter of the aggregate principal amount of the outstanding Notes form a quorum. Any Extraordinary Resolution duly passed at any such meeting shall be binding on all the Noteholders, whether present or not.

Where outstanding Notes belong to more than one Series of Notes:

- (a) business which in the opinion of the Issuer affects the Notes of only one Series of Notes shall be transacted at a separate meeting of the Noteholders of that Series of Notes;
- (b) business which in the opinion of the Issuer affects the Notes of more than one Series of Notes but does not give rise to an actual or potential conflict of interest between the Noteholders of one such Series of Notes and the Noteholders of any other Series of Notes shall be transacted either at separate meetings of the Noteholders of each such Series of Notes or at a single meeting of the Noteholders of all such Series of Notes as the Issuer shall in its absolute discretion determine;
- (c) business which in the opinion of the Issuer affects the Notes of more than one Series of Notes and gives rise to an actual or potential conflict of interest between the Noteholders of one such Series of Notes and the Noteholders of any other such Series of Notes shall be transacted at separate meetings of the Noteholders of each such Series of Notes; and
- (d) as may be necessary to give effect to the above provisions, the provisions on the meetings of Noteholders included in these Conditions and in the Agency Agreement shall be applied as if references to the Notes and Noteholders were to the Notes of the relevant Series of Notes and to the Noteholders of such Notes, including, for the avoidance of doubt the provisions on convening of meetings, quorum and majorities.

B. MODIFICATION

The Notes and these Conditions may be amended without the consent of the Noteholders to correct a manifest error. In addition, the parties to the Agency Agreement may agree to modify any provision of the Agency Agreement, but the Issuer shall not agree, without the consent of the Noteholders, to any such modification unless it is of a formal, minor or technical nature, it is made to correct a manifest error or it is not materially prejudicial to the interests of the Noteholders.

16. FURTHER ISSUES

The Issuer shall be at liberty from time to time without the consent of the Noteholders to create and issue further notes having terms and conditions the same as the Notes or the same in all respects save for the amount and date of the first payment of interest thereon and so that the same shall be consolidated and form a single Series with the outstanding Notes, and references in these Conditions to "Notes" shall be construed accordingly.

17. NOTICES

Notices to the Noteholders will be (i) made by direct mail to the Noteholder having a securities account or to the direct participant holding the securities with the Clearer or by a notice through the intermediary of the Clearer, or (ii) published in one or more financial daily newspaper having general circulation in Brussels (which is expected to be "L'Echo" and/or "De Tijd").

Notices to the Issuer or to the Domiciliary Agent will be made to their respective offices by mail or telefax.

Issuer

Région wallonne
Boulevard du Nord, 8
B-5000 Namur
Phone : 32 (0)81 77 25 00
Fax : 32 (0)81 77 39 20
Attn : Direction du Financement

Domiciliary Agent

BNP Paribas Fortis
Montagne du Parc, 3
B-1000 Brussels
Phone: 32 (0)2 228 92 09
Fax: 32 (0)2 565 98 04
Attn: Documentation Securities- CIB Legal

18. GOVERNING LAW AND JURISDICTION

The Treasury Notes and any non-contractual obligations arising out of or in connection with the Treasury Notes are governed and shall be construed in accordance with Belgian law, and shall be subject to the exclusive jurisdiction of the Courts of Brussels.

FORM OF PRICING SUPPLEMENT

The Pricing Supplement in respect of each Tranche of Series of Notes will be substantially in the following form, duly supplemented (if necessary), amended (if necessary) and completed to reflect the particular terms of the relevant Notes and their issue. Text in this section appearing in italics does not form part of the form of the Pricing Supplement but denotes directions for completing the Pricing Supplement.

Pricing Supplement dated [•]

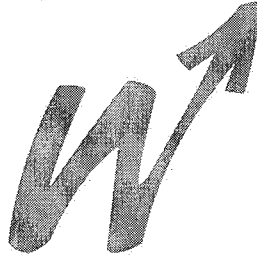

RÉGION WALLONNE

Issue of [aggregate nominal amount of Tranche] [Title of Notes]
under its EUR 743,500,000 Multi-currency Treasury Notes Programme
(the "**Programme**")

This document constitutes the Pricing Supplement relating to the issue of Notes described herein.

Terms used herein shall be deemed to be defined as such for the purposes of the Conditions (the "**Conditions**") set forth in the prospectus relating to the Programme and dated 19 February 2010 (the "**Prospectus**"). The Pricing Supplement contains the final terms of the Notes and must be read in conjunction with the Prospectus [(insert if applicable) and the supplemental prospectus dated [•]], save in respect of the Conditions which are extracted from the prospectus dated [•]]. Full information on the Issuer and the Notes is only available on the basis of the combination of this Pricing Supplement and the Prospectus dated 19 February 2010 [(insert if applicable) and the supplemental prospectus dated [•]]. Copies of the Prospectus [and of its supplement(s)] may be obtained from BNP Paribas Fortis at 3 Montagne du Parc, B-1000 Brussels or from the Issuer (Direction du Financement) at 8 Boulevard du Nord, B-5000 Namur during normal business hours so long as any Notes are outstanding.

This Pricing Supplement does not constitute, and may not be used for the purposes of, an offer or solicitation by anyone in any jurisdiction in which such offer or solicitation is not authorised or to any person to whom it is unlawful to make such offer or solicitation, and no action is being taken to permit an offering of the Notes or the distribution of this Pricing Supplement in any jurisdiction where such action is required.

An investment in the Notes involves certain risks. Prospective investors should carefully consider the information included in the Prospectus and any complementary considerations included in this Pricing Supplement prior to investing in the Notes. Each prospective investor should also carefully consider the tax considerations relating to the Notes included in the Prospectus and any other up-to-date tax considerations that would be relevant for such prospective investor.

Moreover, prospective investors and purchasers of Notes must inform themselves about all the relevant applicable and up-to-date restrictions, including but not limited to, selling and transfer restrictions relating to the Notes, prior to investing in the Notes.

In case of any doubt about the functioning of the Notes or about the risk involved in purchasing the Notes, prospective investors should consult a specialised financial advisor or abstain from investing. Each prospective purchaser of Notes must determine his investment decision based on its own independent review of the information included in the Prospectus and in this Pricing Supplement.

[Include whichever of the following apply or specify as "Not Applicable" (N/A). Note that the numbering should remain as set out below, even if "Not Applicable" is indicated for individual paragraphs or subparagraphs. Italics denote directions for completing the Pricing Supplement.]

- | | | |
|----|--|---|
| 1 | Issuer: | Région Wallonne |
| 2 | (i) Series Number: | [•] |
| | (ii) [Tranche Number: | [•] |
| | (If fungible with an existing Series, details of that Series, including the date on which the Notes become fungible.)] | |
| 3 | Specified Currency: | [•] |
| 4 | Aggregate nominal amount: | |
| | (i) Series: | [•] |
| | (ii) [Tranche: | [•]] |
| 5 | (i) Issue Price: | [•] per cent. of the aggregate nominal amount [plus accrued interest from <i>[insert date]</i> (in the case of fungible issues only, if applicable)] |
| | (ii) [Net proceeds: | [•] (Only to the extent required for listed issues)] |
| 6 | (i) Denominations: | [•] |
| | (ii) Calculation Amount: | [•] |
| 7 | (i) Issue Date: | [•] |
| | (ii) Interest Commencement Date: | [•] |
| 8 | Maturity Date: | <i>[specify date or (for Floating Rate Notes) Interest Payment Date falling in or nearest to the relevant month and year]</i> |
| 9 | Interest basis: | [Non-interest bearing Notes:]

[Discount Notes (Treasury Notes having a maturity up to 1 year)]
[Zero coupon Notes (Treasury Notes having a maturity over 1 year)]

[Interest bearing Notes:]

[[•] per cent. Fixed Rate Notes]

[[<i>specify reference rate</i>] +/- [•] per cent.
Floating Rate Notes]

[Fixed to Floating Rate Notes]
[Floating to Fixed Rate Notes]

(further particulars specified below) |
| 10 | Redemption/Payment basis: | [Redemption at Face Value] |

		[Other (specify)]
11	Change of interest or redemption/payment basis:	[Specify details of any provision for convertibility of Notes into another interest or redemption/payment basis]
12	Redemption at the option of the Issuer	[Applicable/Not Applicable] [[further particulars specified below]]
13	Status of the Notes:	Unsecured and unsubordinated Notes
14	Listing:	[(specify)/None]
15	Method of distribution:	Non-syndicated

PROVISIONS RELATING TO INTEREST (IF ANY) PAYABLE

16	Fixed Rate Note provisions	[Applicable/Not Applicable] <i>(If not applicable, delete the remaining subparagraphs of this paragraph)</i>
	(i) Interest Rate(s):	[•] per cent. per annum [payable [annually/semi-annually/quarterly/ monthly] in arrear]
	(ii) Interest Payment Date(s):	[•] in each [] [adjusted in accordance with [specify Business Day Convention and any applicable Additional Business Centre(s) for the definition of "Business Day"/not adjusted]
	(iii) Interest Period Date(s):	[Each Interest Payment Date / specify if other]
	(iv) Fixed coupon amount [(s)]:	[•] per [•] in nominal amount [per Calculation Amount] [This paragraph shall be filled in if the same Interest Amount is payable on each Interest Payment Date and if Condition 9 D shall then not be applied for each payment initially scheduled]
	(v) Broken amount:	[Insert particulars of any initial or final broken interest amounts which do not correspond with the fixed coupon amount [(s)] and the Interest Payment Date(s) to which they relate – X/N Clearing System regulations specify methods for computing broken amounts]
	(vi) Day Count Fraction:	[specify]
	(vii) Interest Determination Date(s):	[None / [•] in each []]
	(iii) Other terms relating to the method of calculating interest for Fixed Rate Notes:	[Not Applicable/give details]
17	Floating Rate Note provisions	[Applicable/Not Applicable] <i>(If not applicable, delete the remaining sub-</i>

		<i>paragraphs of this paragraph)</i>
(i)	Interest Period(s):	[•]
(ii)	Interest Payment Dates:	[•]
(iii)	Interest Period Date(s):	[Each Interest Payment Date / specify if other]
(iv)	Business Day Convention:	[Floating Rate Business Day Convention/Following Business Day Convention/Modified Following Business Day Convention/Preceding Business Day Convention/other (<i>give details</i>)]
(v)	Additional Business Centre(s):	[•]
(vi)	Manner in which the Interest Rate(s) is/are to be determined:	[specify]
(vii)	Party responsible for calculating the Interest Rates and Interest Amount(s) :	[The Domiciliary Agent / specify if other]
(viii)	Screen rate determination	
	– Reference Rate:	[•]
	– Interest Determination Date(s):	[•]
	– Relevant Screen Page:	[•]
	– Relevant Time:	
(ix)	Margin(s):	[+/-] [•] per cent. per annum
(x)	Floor:	[•] per cent. [per annum]
(xi)	Cap:	[•] per cent. [per annum]
(xii)	Multiplier:	[•]
(xiii)	Day Count Fraction:	[•]
(xiv)	Fall back provisions, rounding provisions, denominator and any other terms relating to the method of calculating interest on Floating Rate Notes, if different from those set out in the Conditions:	[•]
18	Discount Notes provisions (Treasury Notes having a maturity up to 1 year)	[Applicable/Not Applicable] <i>(If not applicable, delete the remaining sub-paragraphs of this paragraph)</i>
	(i) Y (with reference to Condition 8 A 1°):	[•] per cent. per annum
	(ii) C (with reference to Condition 8 A 1°):	[•]
19	Zero coupon Note provisions (Treasury Notes having a maturity over 1 year)	[Applicable/Not Applicable] <i>(If not applicable, delete the remaining sub-paragraphs of this paragraph)</i>
	(i) Y (with reference to Condition 8 A 2°):	[•] per cent. per annum

- (ii) C (with reference to Condition 8 A 2°) [•]
- (iii) Any other formula/basis of determining amount payable: [•]

PROVISIONS RELATING TO REDEMPTION

- 20 Redemption at the option of the Issuer (Call option)** [Applicable/Not Applicable]
(If not applicable, delete the remaining subparagraphs of this paragraph)
- (i) Redemption date(s): [•]
 - (ii) Redemption amount(s) of each Note or calculation method (if any): [•] per Calculation Amount / *[specify if other]*
 - (iii) Notice period: [•]
- 21 Final redemption amount of each Note** [•] per Calculation Amount
- 22 Early Redemption Amount**
- (i) Early redemption amount(s) payable on redemption for taxation reasons (Condition 10D) or on event of default (Condition 14) and/or the method of calculating the same (if required or if different from that set out in the Conditions): [•] per Calculation Amount
 - (ii) Redemption for taxation reasons not permitted on days other than Interest Payment Dates: [Not applicable, Condition 10 D shall apply / Redemption for taxation reasons only permitted on Interest Payment Dates subject to a prior written notice of [•] days to Noteholders in accordance with Condition 17]

GENERAL PROVISIONS APPLICABLE TO THE NOTES

- 23 Form of Notes:** Dematerialised treasury notes: the notes will be in dematerialised form in accordance with the Law of 22 July 1991 on treasury notes and certificates of deposit (as amended) and the Royal Decree of 14 October 1991 on treasury notes and certificates of deposit (as amended) and will be evidenced by book-entry.
- Applicable TEFRA exemption: [C Rules/D Rules/Not Applicable]
- 24 Relevant Financial Centre(s):** [[•] / the Conditions shall apply]
- 25 Other terms or special conditions:** [Not Applicable/give details]

DISTRIBUTION

- 26 Name of the relevant Dealer:** *[give name]*
- 27 Additional selling restrictions:** [Not Applicable/give details]

OPERATIONAL INFORMATION

- 28 ISIN Code: [•]
- 29 Common Code: [•]
- 30 Clearing system(s) (specify clearing system where Notes have primary clearance): [X/N Clearing System/Other (specify)]
- 31 Any clearing system(s) other than X/N Clearing System the relevant identification number(s): [Euroclear Bank S.A./N.V. and Clearstream Banking Société Anonyme / give name(s) and number(s) / Not Applicable]
- 32 X/N Note intended to be held in a manner which would allow Eurosystem eligibility [Not Applicable/Yes/No]
 [Note that the designation "Yes" simply means that the X/N Notes are intended upon issue to be deposited with the National Bank of Belgium and does not necessarily mean that such X/N Notes will be recognised as eligible collateral for Eurosystem monetary policy and intra-day credit operations by the Eurosystem either upon issue or at any or all times during their life. Such recognition will depend upon satisfaction of the Eurosystem eligibility criteria.]
 [Include this text if "Yes" selected]
- 33 Delivery: Delivery [against/free of] payment
- 34 Name and address of Calculation Agent (only in case of Floating Rate Notes): [Not Applicable / [•]]
- GENERAL**
- 35 Additional steps that may only be taken following approval by an Extraordinary Resolution in accordance with Condition 15(A): [Not Applicable/give details]
- 36 The aggregate principal amount of Notes issued has been translated into euro at the rate of [•], producing a sum of (for Notes not denominated in euro): [Not Applicable / euro [•]]

[LISTING APPLICATION

This Pricing Supplement comprises the final terms required to list the issue of Notes described herein pursuant to the € 743,500,000 Multi-currency Treasury Notes Programme of Région wallonne with a listing on the [regulated / specify if other] market of the [specify] stock exchange.]

[OTHER INFORMATION (in case of listing and admission to trading)]

[specify and complete depending on the requirements of the relevant stock exchange]

RESPONSIBILITY

The Issuer accepts responsibility for the information contained in this Pricing Supplement which, when read together with the Prospectus referred to above, contains all information that is material in the context of the issue of the Notes.

Signed on behalf of the Issuer:

By: _____
Duly authorised

DESCRIPTION OF THE ISSUER

THE ISSUER AND ITS FINANCES

1. INSTITUTIONS, COMPETENCES AND ECONOMIC SITUATION OF THE ISSUER

- 1.1. BELGIUM AS A FEDERAL STATE
- 1.2. POLITICAL STRUCTURE
- 1.3. GEOGRAPHICAL LOCATION AND DEMOGRAPHY
- 1.4. ECONOMIC STRUCTURE

2. FINANCES AND BUDGETS OF THE ISSUER

- 2.1. PUBLIC FINANCES
- 2.2. BUDGETS

3. CASH AND DEBT MANAGEMENT OF THE ISSUER

- 3.1. CASH MANAGEMENT
- 3.2. DEBT MANAGEMENT

I. INSTITUTIONS, POWERS AND ECONOMIC SITUATION OF THE ISSUER

1.1. BELGIUM AS A FEDERAL STATE

Belgium became a federal state after a legislative process of nearly 25 years. The five main stages in the federalisation process were :

- 1970** :
- creation of "cultural communities";
 - creation of the first regional institutions : Regional Economic Councils and Regional Development Companies;
- 1980** :
- transformation of the cultural communities into Communities;
 - extension of the powers of the Communities to personal matters and creation of the Regions;
- 1989** :
- devolution of new powers to the Communities and Regions;
 - adoption of the special Finance Act (change from a system of national grants to a system based on the contributory capacity of the Communities and Regions);
- 1993** :
- completion of the federal structure;
 - amendment of the Finance Act;
 - constitutive autonomy granted to the Communities and Regions;
- 2001** :
- expansion of the Communities and Regions' jurisdictions.

The first article of the Belgian Constitution now reads as follows : "*Belgium is a federal state composed of Communities and Regions*".

The country is organised as a federal state, with three main levels of authority:

- a federal government;
- 3 regional authorities (Flanders, Wallonia and Brussels);
- 3 community authorities (Dutch-speaking, French-speaking and German-speaking).

Each body has its own institutions, which consist of a legislative power, i.e. the regional and community parliaments whose members are directly elected, and an executive power, i.e. the regional and community Governments, which enforce the laws. These are called "decrees" or, in the case of the Region of Brussels-Capital, "orders".

The regional powers are based on the notion of territoriality and are mainly related to economic matters, such as economic policy, town and country planning, foreign trade, public works, environment, health care, etc..., whereas Communities are based on the notion of personality and are competent for "personal matters", such as education and culture.

The consensus is organised in such a way that the exclusive powers of each authority are not authorised to interfere with matters under the jurisdiction of another authority, but nevertheless there is no hierarchy between them : regional and community decrees have the same legal force as federal laws.

1.2. POLITICAL STRUCTURE

The Walloon's government is headed by Minister-President Rudy DEMOTTE; 4 parties are represented in the Walloon Parliament, with seats distributed as shown in the following graph. The coalition in place is formed by an alliance between Socialists, Democrats and Ecologists (majority with 56 seats out of 75):

*COMPOSITION OF THE PARLIAMENT - ELECTIONS ON JUNE 7TH 2009
(NUMBER OF SEATS)*

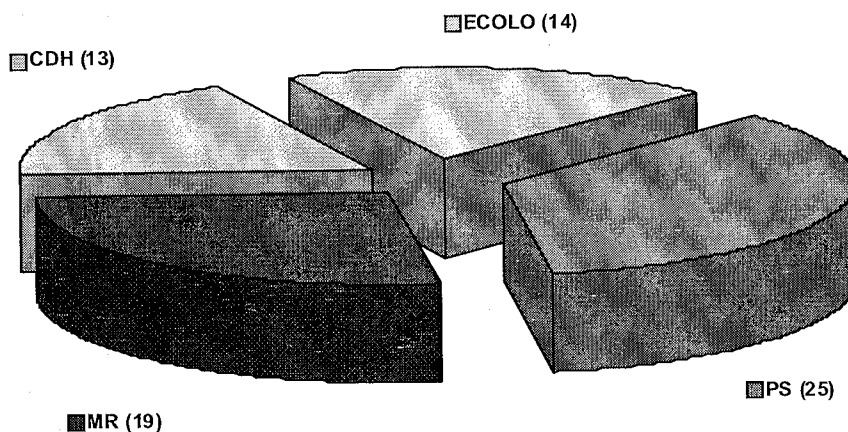

1.3. GEOGRAPHICAL LOCATION AND DEMOGRAPHY

1.3.1. Geographical location

Wallonia has a gross area of 16 844 sq. km and is located in the immediate vicinity of Brussels and major western European cities.

Its central location in the E.C. is a geographical advantage in terms of trade and commerce. This is all the more the case as Wallonia is ideally equipped with a very dense road and railroad infrastructure.

In 2007 the Walloon road network amounted to 8,452 km with 869 km of motorways and 6,869 km of regional roads¹. It should also be pointed out that Wallonia has the densest railway network per inhabitant in the world with an infrastructure amounting to 1,639 km.

Moreover, with its two international airports (Brussels South Airport and Bierset), Wallonia can be reached in less than 90 minutes from any city. Additionally, many links can be established by large outline canals facilitating waterways traffic between the Rhine, the Maas and the Scheldt.

1.3.2. Demography

1.3.2.1. General

According to the most recent figures available² (2007), the Walloon population amounts to 3,435,879 inhabitants, which represents 32.5 % of the Belgian population. With a density of 204 inhabitants per sq. km, Wallonia is far below the national average of 347 inhabitants per sq. km.

The Issuer has a high percentage of children in full-time education. There are indeed more than 2,500 schools in Wallonia as a result of the compulsory school education between 16 and 18³.

¹ Institut Wallon de l'Évaluation, de la Prospective et de la Statistiques (IWEPS) – mise à jour 12/05/2009.

² IWEPS, statistiques démographiques, Institut National de Statistiques (INS).

Those statistics indicate that foreigners represent 10 % of the Walloon population.

1.3.2.2. Population Structure

The following table represents the age structure of the Walloon population in 2007:

Population per age (updated February 2008)				
Age category	Wallonia	%	Belgium	%
00-04 years	197.560	5,75%	590.156	5,58%
05-09 years	205.052	5,97%	591.860	5,59%
10-14 years	209.889	6,11%	615.713	5,82%
Subtotal 0-14 years	612.501	17,83%	1.797.729	16,98%
15-19 years	225.342	6,56%	643.400	6,08%
20-24 years	210.051	6,11%	637.132	6,02%
25-29 years	206.170	6,00%	678.363	6,41%
30-34 years	222.430	6,47%	691.381	6,53%
35-39 years	241.598	7,03%	762.997	7,21%
40-44 years	256.591	7,47%	816.756	7,72%
45-49 years	255.124	7,43%	793.170	7,49%
50-54 years	238.924	6,95%	727.852	6,88%
55-59 years	228.918	6,66%	672.805	6,36%
60-64 years	170.253	4,96%	552.887	5,22%
Subtotal 15-64 years	2.255.401	65,64%	6.976.743	65,91%
65-69 years	143.225	4,17%	471.769	4,46%
70-74 years	138.710	4,04%	455.134	4,30%
75-79 years	128.532	3,74%	399.520	3,77%
80-84 years	95.073	2,77%	288.964	2,73%
85-89 years	43.635	1,27%	133.068	1,26%
90-94 years	14.961	0,44%	48.595	0,46%
>95 years	3.841	0,11%	13.012	0,12%
Subtotal ≥65 years	567.977	16,53%	1.810.062	17,10%
Total	3.435.879	100,00%	10.584.534	100,00%

1.4. ECONOMIC STRUCTURE

1.4.1. Economic sectors

In 2005, the industrial sector's added value⁴ (in costs approach) in current prices was divided up as follows :

STRUCTURE OF THE INDUSTRIAL ADDED VALUE (PART IN % OF THE TOTAL)

	2005
Chemical industry	25.9
Metallic industry	18.5
Machines & Equipments	19.4
Food & agricultural industry	12.3
Mineral product industry	10.7
Others	13.2

The next table shows the contribution of the different sectors to the global added value of the Issuer. Between 1995 and 2007, we can observe a growth of the private sector's contribution, suggesting a higher dynamism from

³ Ministère de la Communauté française, « l'enseignement en chiffres 2006-2007 ».

⁴ UWE, « situation de l'industrie wallonne », Banque Nationale de Belgique (Institut des Comptes Nationaux - ICN), calculs UWE, 29/11/2007.

the companies. The contribution of the public sector remains stable over the same period, while the one of the self-employed continues to decrease.

STRUCTURE OF THE GLOBAL ADDED VALUE (PARTS IN % OF THE TOTAL)

	1995		2007	
	M€	%	M€	%
Total economy	44,958	100.0%	69,259	100.0%
Companies	25,050	55.7%	40,832	59.0%
Public administration	9,075	20.2%	13,879	20.0%
Self-employed	10,832	24.1%	14,548	21.0%

1.4.2. Economic growth

In order to analyse the economic growth of the Issuer, we have to take the evolution of the added value as a whole into account, i.e. the Walloon Gross Domestic Product.

In the following table, we can see some quantitative elements which enable us to appreciate the current situation of the Walloon economic development.

EVOLUTION OF THE GROSS DOMESTIC PRODUCT (IN VOLUME)⁵

	2000	2005	2006	2007	2008	2009
In M€						
Wallonia	59,410	64,341	65,771	66,920	67,790 (f)	65,001 (f)
In % of Belgium						
Wallonia	23.6	23.6	23.4	23.2	23.3 (f)	23.2 (f)

(f) = forecasts: IWEPS (Tendances économiques, juin 2009)

The Walloon gross domestic product reached the amount of 65,771 million euro in 2006, which represents an average product/inhabitant of 21,700 euro. This purchasing power ratio⁶ indicator equalled 71.9 % of the Belgian GDP/inhabitant (Belgium = 100%) while the EU-15 amounted to 92.6% and the EU-27 to 78.1 %.

1.4.3. Labour Market

1.4.3.1. Working population

The following diagram shows the activity structure of the population in Wallonia in 2008⁷.

⁵ IWEPS, « les chiffres-clés de la Wallonie N°10 », décembre 2009.

⁶ Note: the GDPs are expressed as purchasing power ratio, which means that the price levels between countries are erased to allow an international comparison.

⁷ IWEPS, « Les chiffres-clés de la Wallonie N°10 », décembre 2009.

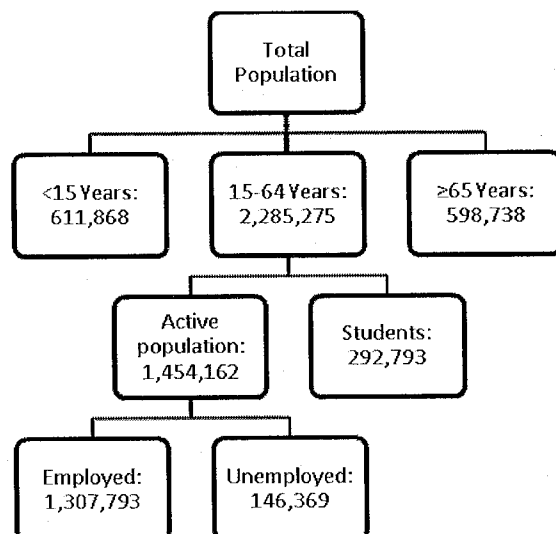

This scheme shows that 65.9% of the total Walloon population has the legal age to work (15-64 Years). Among those individuals, 63.6% are available on the labour market while 2.3% are still studying. From the active population, 1,307,793 individuals are employed. It should be noted that many people, essentially self employed, continue to work after their 64th birthday.

The regional domestic labour corresponds to the employment created on a specific regional area with no distinction of the regional origin of the workers. The sectors with the highest employment rate in Wallonia are: commercial business, real estate, health and social, industry and public.

1.4.3.2. Employment and unemployment rates as a percentage of the working population

The following table illustrates the evolution of the employment and unemployment rates of the working age population for the period 2004-2009:

*EMPLOYMENT AND UNEMPLOYMENT RATE IN WALLONIA*⁸

	Employment rate	Unemployment rate
2004	55.1%	12.1%
2005	56.1%	11.9%
2006	56.1%	11.8%
2007	57.0%	10.5%
2008	57.2%	10.1%
2009*	59.9%	11.8%

*: figures of the 1st quarter 2009

We can observe that from 2004 until 2008, the unemployment rate has decreased. Unfortunately the figures for the first quarter in 2009 show a substantial increase of the unemployment rate.

However, the employment rate (calculated in relation to the working age (15 to 64) population) has been constantly increasing from 2004 onwards.

1.4.4. Foreign trade⁹

As illustrated in the following graph, Walloon exports (ICN figures) are extremely concentrated as regards their sector of origin.

⁸ IWEPS, « Les chiffres-clés de la Wallonie N°10 », décembre 2009.

⁹ AWEX, Informations marchés et secteurs / stats export, 2009.

- Metallurgical industry : 22.8 %
- Chemical industry, plastic industry, rubber industry : 20.1%
- Machine and appliances, picture and sound devices, electrical appliances : 12.3 %

These three main sectors represent 55.2% of the Walloon exports in 2008.

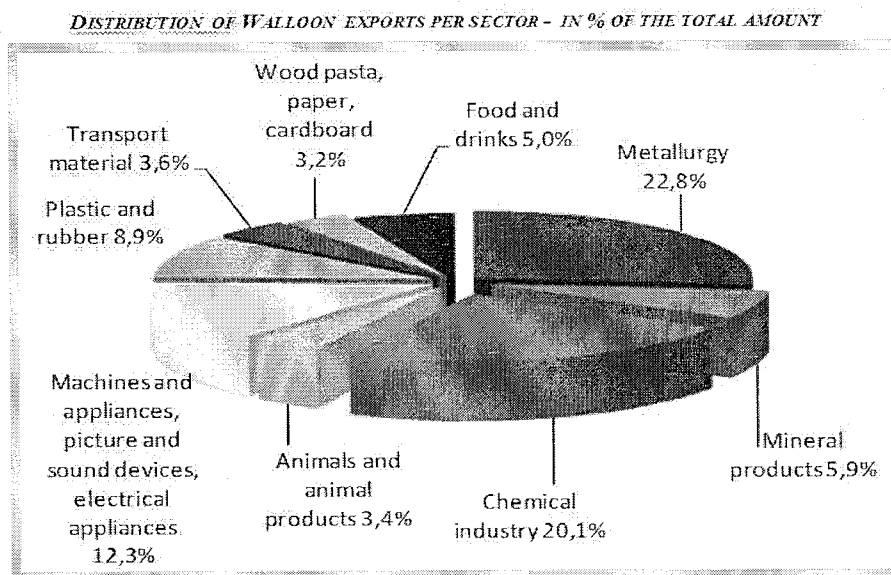

In term of destination, as shown in the following graph, Walloon exports are essentially concentrated with bordering countries :

- France : 27.39 %
- Germany : 15.36 %
- The Netherlands : 8.76 %

The exports to these three countries amount to 51.5 % of the total exports for 2008. The majority of the Walloon exports are realised within the EU27 zone.

The exports to non-EU27 countries are mainly realised with:

- USA: 4.53%
- Russia: 1.13%
- China: 1.04%

GEOGRAPHICAL SHARING OUT OF WALLOON EXPORTS AMONG BIG AREAS

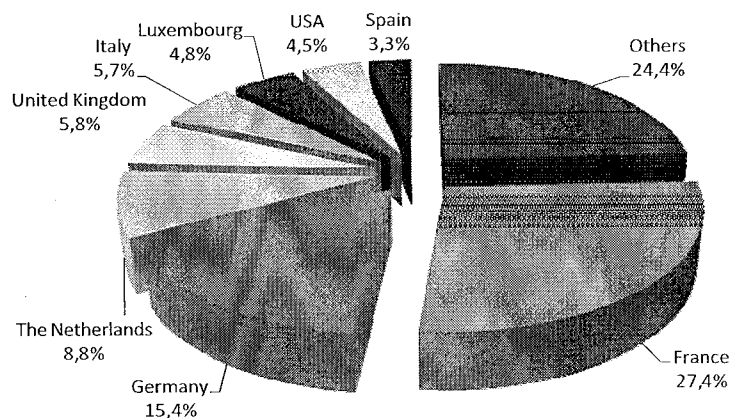

2.1. PUBLIC FINANCES

BEFORE 1989

The Finance Act of 16 January 1989 defines the current financing system of the Communities and Regions.

Before the implementation of the above-mentioned Finance Act, the financing of both Communities and Regions was essentially based on grants ("dotations") received from the federal government representing ¾ of their needs.

This type of financing (grants) was supplemented by Regional taxes, which already allowed a certain degree of fiscal autonomy.

It has to be pointed out that, although there was the possibility to resort to public borrowing, neither the Communities nor the Regions effectively used this opportunity.

THE FINANCE ACT OF 1989

The Finance Act of 1989 radically changed the system of grants by imposing financial responsibility to each Community and Region.

In the long run, each Region will only be able to count on its own resources (*principle of "fair return"*). In order to ensure a smooth transition between the funding system of 1989 and that of 1999 (i.e. the transition from a system of grants to a system based on the contributory capacity of the Communities and Regions), the new system provides for a *transitional period* of 10 years before the *period of definitive implementation* beginning in 2000.

The Constitution and the special Act list the means which should allow the Issuer to finance its budget.

a) Own taxation

It is the taxing competence granted by the Constitution.

This concept provides for new taxes which the Issuer will levy in the future as it is done in the fields of water and waste.

This tax-levying competence includes defining the object of taxation as well as fixing the tax base and rates or granting exemptions.

b) Non-tax revenues

Revenues ensuing from the exercise of the powers granted to the Issuer: own non-tax revenues (property revenue, service taxes, etc...).

c) Allocated portions of national tax revenues

The Issuer derives most of its funding from shared taxation. In this system the object of taxation, the tax base, the tax rates, the exemptions and the collection are national matters, but a portion of the revenues is allocated to the Issuer, generally in proportion to its contribution.

These taxes are called "joint taxes" with respect to the Issuer as it can levy additional taxes (e.g. in addition to the income tax).

d) Regional taxes

These are taxes levied by the State and fully or partially refunded to the Issuer depending where they were levied.

The Issuer has certain prerogatives with respect to this refunded taxation (modification of tax rate, exemptions, etc...) which consist of :

- property tax;
- registration fees;
- death duties;
- tax on games and gambling;
- tax on automatic leisure machines;
- tax on the opening of drinking establishments.

e) National solidarity grant

An annual national solidarity grant is allocated to the Regions whose income tax revenue is below the national average.

f) Loans and bonds

The Communities and Regions can borrow on the Belgian market or abroad.

Moreover, in order to supervise the debts of the different levels of authority and to preserve the cohesion of the economic and monetary union, the Superior Finance Council annually formulates recommendations on the need to restrict the borrowing capacity of any public authority.

The revenues of the Communities and Regions are granted by the Finance Act. In case of delayed or insufficient payment by the federal State, the Communities and Regions can borrow the unpaid amounts with state guarantee, the interests being borne by the federal Government.

2.2. BUDGETS

The budget of the Region is an essential element for the conversion of its policies into figures.

The 2010 budget of the Issuer, which was adopted on December 10th 2009 by the Walloon Parliament, amounts to 7,122 billion.

The following table shows the total budgetary balances as follows :

(in thousands EUR)	2010
Receipts	6,340,957
Expenses	7,122,024
Gross financing requirement	-781,067
Debt redemption	35,269
Net financing requirement	-745,798

2.2.1. Resources of the Issuer

Three types of revenues are considered. First of all, the allocated means from the federal State represent 55.27% of total revenues in 2009. These are composed of the personal income tax and the drawing rights on the Federal Ministry of Employment which respectively represent 52.40% and 2.87% of the 2009 receipts.

The regional revenues, representing 39.68% of total revenues in 2009, are a second source of receipts for the Issuer (regional taxes and other regional revenues respectively represent 33.95% and 5.73% of the 2009 receipts).

The grants from the French Community, amounting to 5.05% of total revenues in 2009, are another source of revenue for the Issuer. The aim of this special grant is to partly finance the competences that were transferred from the French Community to the Issuer (sports infrastructures, tourism, training of freelance workers, handicapped policy...).

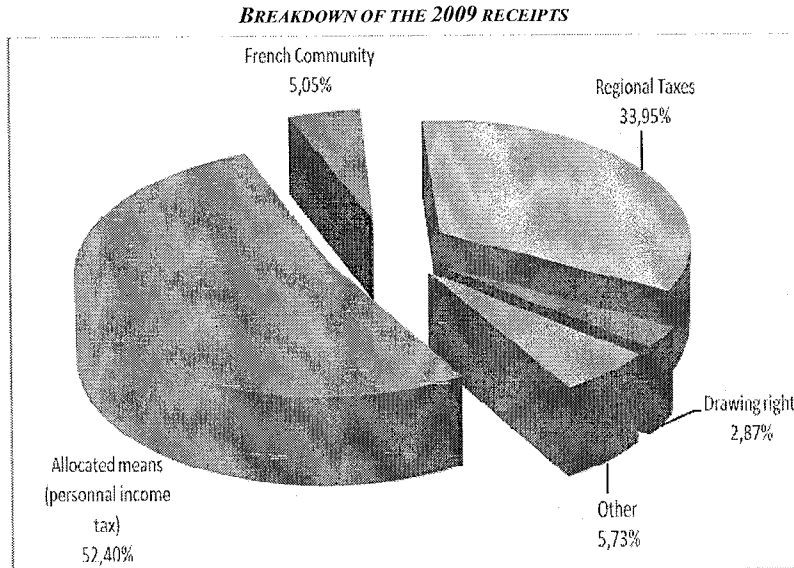

2.2.2. Expenditures of the Issuer

Regional expenses in 2009 are as follows :

BREAKDOWN OF THE 2009 EXPENDITURES

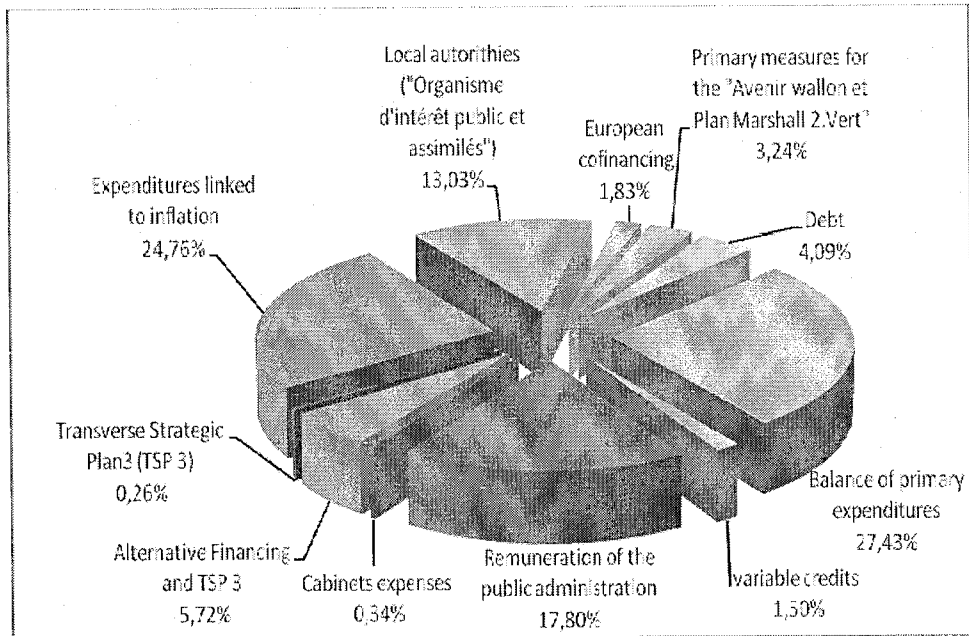

3. THE CASH AND DEBT MANAGEMENT OF THE ISSUER

3.1. CASH MANAGEMENT

From the 1st day of its autonomy, (i.e. 01.01.1991) the Issuer has been able to manage a very efficient treasury mainly based on :

- automatic cash flow management
- inflow estimates (receipts)
- outflow parameterisation (expenses)
- centralisation of all cash movements with a single cashier
- maintenance of credit facilities

Regional receipts consist of allocated means received from the federal State and the French Community as well as the receipts that are directly collected by the Issuer.

Regional expenses can be divided in two categories :

- 1) Parameterised expenses which amounts and disbursement dates are predetermined. Parameterisation is based on budgetary data (amounts) and legal, decretal, regulatory or conventional norms (payment dates). These forecasts are constantly adjusted according to budget modifications and effective expenses during the budgetary year.
- 2) Other expenses, which represent a little more than 1/3 of the total expenses and which are more difficult to forecast.

During the budgetary year 2009, receipts were collected and expenses implemented at the following rate :

EVOLUTION OF RECEIPTS AND DISBURSEMENTS FROM JULY 2008 TO JUNE 2009 (IN MILLION EUR)

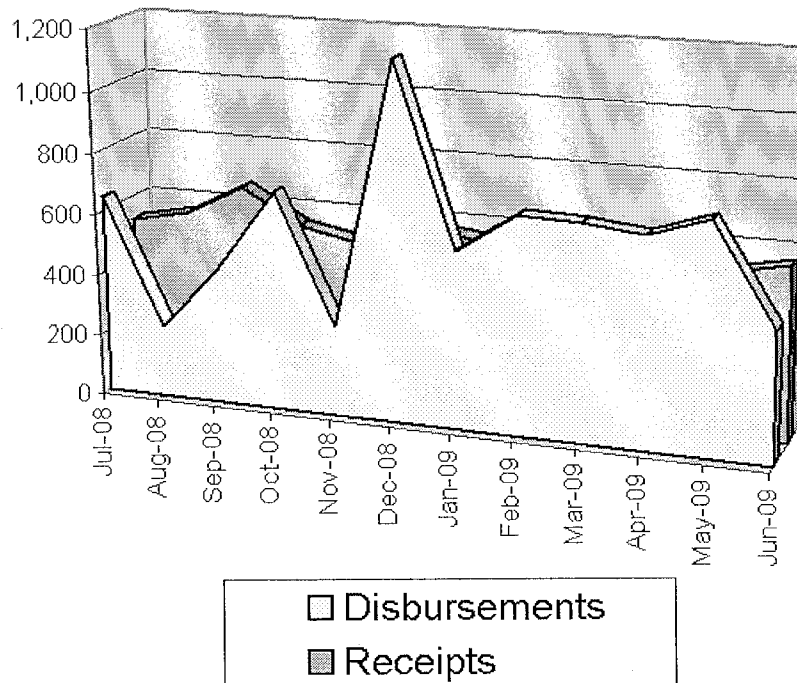

In order to have a coherent cash management, all balances are consolidated so as to determine a global cash state.

The following graph illustrates the annual cash cycle and enables us to analyse the evolution of the daily global state as well as the collection and implementation rates with regard to receipts.

**REAL CASH CYCLE (CASH MANAGEMENT OPERATIONS NOT INCLUDED) FROM JULY 2008 TO JUNE 2009
(IN THOUSAND EUR)**

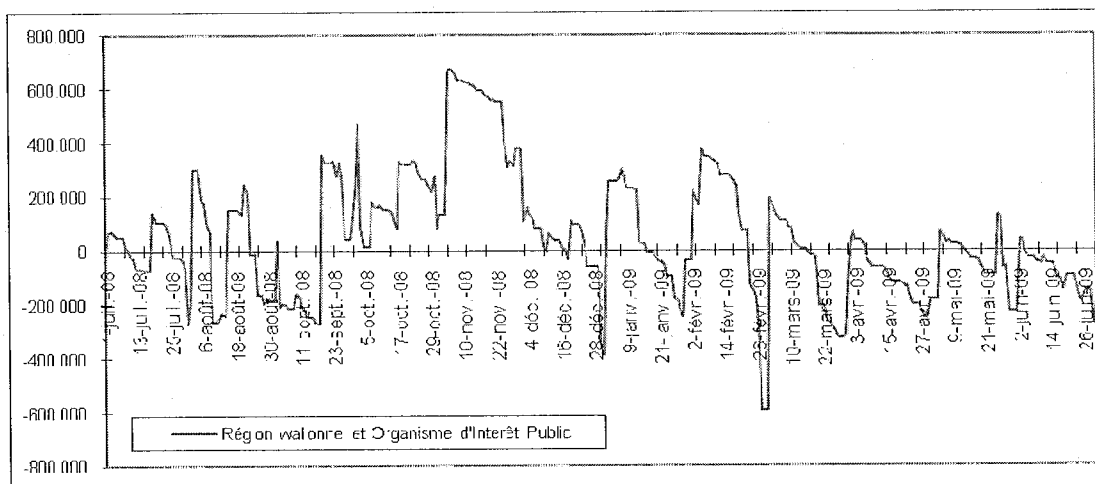

3.2. DEBT MANAGEMENT

3.2.1. The principles of regional debt management

Four main principles govern the Issuer's debt management.

Harmonisation of debt financing and management operations

All operations pertaining to the financing and management of the direct and indirect debt have been harmonized.

In this way, the budget of the Issuer includes all debt costs, whether direct or indirect, in a distinct budget. Moreover, the Accounts Department manages these matters without interference of the functional services.

Optimal diversification of debt components

It is through the definition of a fixed rate/floating rate ratio that this second principle of management is implemented. This ratio, periodically adapted according to the evolution of the interest rate curve, has mainly allowed to reduce the cost of financing in a drastic way.

Contracting part of the debt at a floating rate obviously induces a lower financing cost when the rate curve is positive, which has been observed the last few years. When that curve becomes flatter or even negative, caution and a reduction of interest costs are necessary, which induces a higher part of fixed rate.

Active use of financial instruments

The financial instruments and the best adapted products have been actively used since 1993 within the context of the debt management of the Issuer, while systematically excluding any speculative aspect.

The Issuer uses instruments such as interest rate swaps, forward rate agreements (FRA's), futures, and options.

Set up of financing programs

The Issuer has also two programs enabling it to attract short and long term financing.

The use of these programs brings three advantages :

- a reduction of the financing costs compared with the common long-term conditions;
- the possibility of prompt reaction which makes it possible to take advantage of opportunities on the capital markets (stand alone documentation is a more lengthy process);
- an increase and diversification of the investor base.

3.2.2. Direct debt

The direct debt of the Issuer is determined by the sum of the annual differences between budget receipts and expenditures. This difference represents the gross budget balance to finance which, after deduction of the consolidated debt redemption, represents the net balance to finance.

a) Direct outstanding debt (in million EUR) :

Year	Borrowings	Redemption (direct debt)	Borrowed amounts to repay the redemptions (direct and indirect debt)	Direct debt outstanding on the 31/12
2002	200,2	245,4	344,5	2.666,4
2003	2,3	764,7	862,3	2.766,3
2003				3.450,5 (*)
2004	0,0	495,7	499,0	3.453,8
2005	-10,5 (**)	459,1	474,2	3.458,3 (01/01/06)
2006	8,2 (***)	110,1	112,7	3.469,1 (01/01/07)
2007	0,0	318,8	321,4	3.471,7
2008	0,0	418,5	345,0	3.408,3 (****)
2009	0,0	397,2 (****)	330,0	3.416,5 (est. *****).

(*): amount of indirect debt transferred on the 31 December 2003 : EUR 684,1 million.

(**): the stock of direct debt has been reduced by EUR 10,6 million on the 1st January 2006; this correction is due to different methodologies to compute the redemption of some loans with constant annuities.

(***): as of the 1st January 2007, an amount of EUR 8,2 million has been transferred from the indirect debt to the direct debt. This amount represent loans initially granted by the IFAPME and that were not consolidated.

(****): an amount of 75.4 million EUR (representing part of the 2008 redemption) will have to be refinanced in 2009.

(*****): an amount of 70 million EUR (representing part of the 2009 redemption) will have to be refinanced in 2010.

b) Implicit rate and average life

The evolution of the implicit rate (i.e. the amount of interests paid annually in relation to the debt stock) during the period 2002-2008 is illustrated in the table below :

IMPLICIT RATE OF DIRECT REGIONAL DEBT 2002-2008

Year	Implicit rate (in %)
2002	4,68
2003	4,83
2004	4,58
2005	4,74
2006(*)	4,23
2007(*)	4,54
2008(*)	4,19 (**)

(*): It should be noted that the implicit rate is calculated for the direct debt taking into account a new perimeter (i.e. including a part of the indirect debt which was transferred to the direct debt) as of 2006.

(**): an amount of 75.4 million EUR (representing part of the 2008 redemption) will have to be refinanced in 2009.

A dynamic management of the debt has allowed the Issuer to finance itself at an implicit rate of 4.19 % for 2008, keeping the level of risk completely under control.

The following graph illustrates the weighted average life of the direct debt of the Issuer on 31st December :

AVERAGE LENGTH OF DIRECT DEBT STOCK : EVOLUTION 2007-2009

	2007	2008	2009 (30/06/09)
Total direct debt	9.30	10.26	10.26

3.2.3. Indirect debt

The fact that the Issuer never resorted to direct debt before 1991 does not imply that there were no debt related to competences which were transferred to the Issuer. Some expenditures were indeed financed outside the budget but had an impact on the debt level.

Indirect Debt (in thousands EUR)	31/12/2009
1) Loans for which the Issuer reimburse <u>all</u> the charges Real estate for the Issuer SPABS	795.354,37
2) Loans for which the Issuer reimburse <u>part</u> of the charges No assets for the Issuer SWCS (loans dating from 1987-1988) Assets for the Issuer SWDE	9.292,95 4.471,63
Total Indirect Debt	809.118,95

3.2.4. Guaranteed debt

The Issuer gives its guarantee to several loans, among others to those floated by public bodies to subordinate authorities and to the loans municipalities hit by disaster have subscribed to.

The granting of the Regional guarantee has a very limited impact or no impact at all on the budget, as a result of the very limited risk supported by the Issuer. This impact amounts to a few millions every year.

<u>31.12.2003</u>	<u>31.12.2004</u>	<u>31.12.2005</u>	<u>31.12.2006</u>	<u>31.12.2007</u>	<u>31.12.2008</u>
2.036.408.808,81	2.363.575.588,95	2.546.605.844,61	2.799.815.749,09	3.161.947.010,53	4.484.036.189,99

3.2.5. Rating

On the 15th January 2009, Moody's has confirmed the Aa2 rating of the Issuer for its long-term debt. Nevertheless the positive outlook was reduced to a stable one, following the same change in outlook perspective for the federal State.

TAXATION IN BELGIUM

THIS SECTION PROVIDES A GENERAL DESCRIPTION OF CERTAIN BELGIAN LEGAL/TAX ISSUES AND CONSEQUENCES OF ACQUIRING, HOLDING, REDEEMING AND/OR DISPOSING OF THE TREASURY NOTES, BASED ON BELGIAN LEGISLATION AND REGULATIONS AND ON A CLEARING AGREEMENT SIGNED BETWEEN THE ISSUER, THE DOMICILIARY AGENT AND THE CLEARER.

The summary below provides general information only and is restricted to the matters stated therein. It is intended neither as legal/tax advice nor as a comprehensive description of Belgian laws and practices currently applicable. It is based on the information provided in the Prospectus and on Belgian laws, regulations, resolutions and other public rules with legal effect, and the interpretation thereof under published case law, all as in effect on the date of this Prospectus, which are subject to change, potentially with retrospective effect. Prospective acquirers are urged to consult their own advisors concerning the detailed and overall legal/tax consequences of acquiring, holding, redeeming and/or disposing of the Notes.

Terms not otherwise defined herein shall have the same meaning as in the Conditions.

1. DESCRIPTION OF THE BELGIAN CLEARING SYSTEM

▪ GENERAL

The Clearing of dematerialised Treasury Notes is organised by the law of 6 August 1993 and the Royal Decree of 26 May 1994 and 14 June 1994.

The securities clearing system of the Clearer has been approved by a Royal Decree of 14 June 1994.

Securities accounts in the approved Clearing System can be :

- Exempt Accounts or X-accounts for investors for which withholding tax does not constitute the final tax (companies subject to corporate tax, non-residents, ...), as well as for public sector entities (such as municipalities). No withholding tax is deducted on payments in respect of securities held on such accounts (coupons or premium on issue price);
- Non-Exempt Accounts N-accounts for investors for which withholding tax constitutes the final tax (such as private individuals). The Clearer deducts withholding tax from any payments to the investor in respect of securities held on such accounts.

Further to this principle, tax clearing operates on transactions between X and N accounts, in order to ensure the levy of withholding tax on payments to non exempt investors (deduction of withholding tax) and also to avoid such investors bearing withholding tax on a full coupon when they purchase a security in the course of the coupon period (reimbursement of withholding tax). Investors holding securities on an X-account are always credited with the gross revenue.

▪ CLEARING AGREEMENT

The Issuer has concluded the Clearing Agreement with the Domiciliary Agent and with the Clearer for clearing operations regarding dematerialised treasury notes.

All commitments and rights established by the Clearing Agreement for the Issuer's account are executed directly by the Issuer or by the Domiciliary Agent acting on behalf of the Issuer.

If another Domiciliary Agent is appointed, the Issuer is bound to notify the Clearer in writing about this substitution, an appendix to the Clearing Agreement will then be drawn up, mentioning the new Domiciliary Agent. In any case, the substitution of Domiciliary Agent will come into effect only for issuances that will take place after the date whereon the substitution has been notified and for securities that have received another ISIN code than those allocated to the securities that have been issued before the substitution of the Domiciliary Agent.

For all issuances preceding the change of Domiciliary Agent, the initial Domiciliary Agent will remain entirely committed to its obligations resulting from the agreement.

▪ ISSUANCE PROCEDURE

At 11 a.m. (Brussels Time), at the latest, on the settlement day for securities denominated in euro and on the preceding banking day for securities denominated in Foreign Currencies, the Domiciliary Agent informs the Clearer about the specific terms of the planned issue (including ISIN code, nominal amount of the securities, issue price and the redemption price, settlement date and maturity date, interest rate or yield, ...).

On the settlement date, the Clearer credits the securities account of the Domiciliary Agent in accordance with the clearing regulations.

Subsequently, at the latest on the settlement date, the Domiciliary Agent allocates the amounts of the subscribed securities among the holders of the securities accounts of all subscribers, according to the usual regulations of the Clearing System.

Delivery through a Euroclear or Clearstream account can be made. In such case, the delivery will be made on the good value date, but the actual delivery may occur one business day after the issue date, depending on certain technical constraints.

▪ PAYMENTS

On the banking day preceding the maturity date or any interest payment date of the securities after the definitive clearing, the Clearer automatically performs the notifications for the repayment of maturing securities or of the interest due.

A. in EUR

On the interest payment date, the cash account of the Domiciliary Agent is debited with the amount of the interest due.

The cash accounts of the participants are credited with the interest due in accordance with the amounts of the securities registered therein, after deduction of the withholding tax, if any.

On the maturity date of the securities, the securities accounts of the participants are debited with the amount of such matured securities registered therein.

Correspondingly, the cash account of the Domiciliary Agent is debited with the amount of the matured securities. The cash accounts of the participants are credited with the amount of the matured securities duly registered therein, after deduction of the withholding tax, if any.

The Issuer has undertaken to provide sufficient funds through the intermediary of its Domiciliary Agent, in order to meet, on due date, the total repayment of all amounts due in capital and interests.

B. in other currencies

The interest due and the redeemable principal of dematerialised securities denominated in Foreign Currencies, are payable by the Issuer or by its Domiciliary Agent, if applicable after deduction of the withholding tax, to the participants keeping the accounts in which such securities are registered, on the basis of the amounts recorded at the end of the third banking day preceding the interest payment date or the maturity date as such amounts are provided for by the Clearing System.

On the maturity date, the Domiciliary Agent pays in Euro in favour of the Clearer the amount of the withholding tax which is due by the Clearer to the Treasury, pursuant to article 8 of the Law of 6 August 1993 regarding operations on certain securities, pursuant to its implementation provisions concerning the conversion into euro of securities denominated in foreign currencies and in accordance with regulation (CE) nr 1103/97 of the Council dated June 17, 1997.

▪ ISSUER'S DEFAULT

In case of default of the Issuer, or should there be insufficient funds available, any redemption at maturity or any payment of interest will be postponed *ipso jure* until a sufficient credit balance is provided for to guarantee the full settlement of all payments due by the Issuer.

The Domiciliary Agent must see to notify the Issuer's default or lack of cash to the Clearer as soon as possible and, for Notes denominated in EUR, at the latest before 10 a.m. on the due date for redemption of capital or payment of interests.

After this time limit, the execution of the capital redemption procedures or of interest payment in EUR is supposed to have been accepted by the Domiciliary Agent, whose account is consequently debited.

The notice to be addressed to the Clearer by the Domiciliary Agent has to be made by registered letter with acknowledgement of receipt. In case of emergency, the notice may be made by Swift message or by telefax, with a letter a confirmation by registered mail with acknowledgement of receipt. The parties will agree in advance on the form to be used for Swift messages.

▪ GOVERNING LAW OF THE CLEARING AGREEMENT, JURISDICTIONS, MISCELLANEOUS

The Clearing System, its regulations and the Clearing Agreement are governed by Belgian law.

The clearing regulations have to be applied to anything, which is not specifically provided for in the Clearing Agreement.

2. BELGIAN TAXATION

For Belgian tax purposes, interest includes any interest paid on the Treasury Notes as well as any amount paid in excess of the initial issue price upon redemption or purchase by the Issuer.

▪ WITHHOLDING TAX

Under current Belgian tax law, all interest payments in respect of the Treasury Notes will in principle be subject to withholding tax on the gross amount of the interest, currently at the rate of 15%. Tax treaties may provide for a lower rate subject to certain conditions.

However, the Treasury Notes issued under the Programme will be cleared in the X/N clearing system of the National Bank of Belgium. Consequently, they will benefit from the application of the Law of 6 August 1993 on Transactions on Certain Securities, as amended, and its implementing Royal Decrees of 26 May 1994 and 14 June 1994.

Hence, the deduction, or the absence of deduction, of Belgian withholding tax on payments in respect of the Treasury Notes will be governed by the following principles:

1. The Treasury Notes shall be booked on the securities account held by the Noteholder(s) with its (their) Custodian, which securities account will be either an X-account or an N-account"
 - (a) *X accounts or exempt accounts are securities accounts opened in the name of persons or institutions referred to in Article 4 of the Royal Decree of 26 May 1994, as amended (see the chapter "Exempt Account Holders" below for the list of these persons and institutions,) which benefit from exemption from withholding tax.*
 - (b) *Each person or institution qualifying to hold an X-Account shall provide its Custodian with a certificate evidencing that it belongs to one of the above categories. It shall immediately inform its Custodian of any changes to the information contained in the certificate.*
 - (c) *In the event that a person or institution ceases to belong to one of the categories defined in Article 4 of the Royal Decree of 26 May, 1994, as amended by the Royal Decrees of 6 September, 1998 and 9 January, 2005 its securities account will become an N-account*
 - (d) *N-accounts or non-exempt accounts are securities accounts opened in the name of persons or institutions that do not qualify to hold an X-account, and which do not benefit from an exemption from withholding tax.*
2. The following persons or institutions (as defined in Article 4 of the Royal Decree of 26 May 1994) are entitled to hold the Treasury Notes in an Exempt Account:
 - (a) *Belgian resident companies subject to corporate income tax;*
 - (b) *Belgian qualifying pension funds in the form of an ASBL/VZW ;*
 - (c) *semi-public social security institutions or institutions similar thereto;*
 - (d) *non-resident individuals or non-profit organizations which have not allocated the capital producing the revenue to the exercise of a professional activity in Belgium;*
 - (e) *investment funds approved for pension savings schemes;*
 - (f) *non-resident companies subject to non-resident corporate tax, which have allocated the capital producing the revenue to the exercise of their professional activity in Belgium;*
 - (g) *the Belgian State, for its investments exempt from withholding tax;*
 - (h) *foreign mutual investment funds, which are not separate legal entities, provided that the participation certificates are not offered publicly in Belgium and are not traded in Belgium;*
 - (i) *Belgian resident companies not referred to under (a). and whose sole or main activity is the granting of credits and loans;*
 - (j) *Only for the income from debt securities issued by legal persons belonging to the public sector, the legal entities which belong to the public sector.*
3. Subject to applicable law, all payments by the Issuer in respect of the Treasury Notes will be made:
 - (a) *without deduction of withholding tax if the Treasury Notes are booked on an X-account of the Noteholder*
 - (b) *after deduction of withholding tax on interest if the Treasury Notes are booked on an N-account of the Noteholder.*
4. No additional amounts shall be payable with respect to any Treasury Note to, or to a third party on behalf of, any Noteholder:
 - (a) *if the levy of withholding tax in respect of such Treasury Note is a result of the Noteholder's own failure to hold the Note in an X-account in accordance with the law of August 6, 1993, the royal decree of May 26, 1994 and the derivative rules as amended from time to time, or of its own infringement of this legislation;*

- (b) if the levy of withholding tax in respect of such Treasury Note is due to the Noteholder having some connection with the Kingdom of Belgium other than (i) the mere holding of such Treasury Note or (ii) the receipt of any payments in respect of such Treasury Note;
- (c) if the levy of withholding tax in respect of such Treasury Note is due to the Noteholder not having fulfilled certain formalities or not having made a declaration of non-residence or other similar claim for exemption to the relevant tax authority; and
- (d) if the levy of withholding tax in respect of such Treasury Note is the result of the Note being booked on an N-account.

5. Subject to applicable law, transfers of Treasury Notes between an X-Account and an N-Account will give rise to certain adjustment payments on account of withholding tax:

- (a) a transfer from an N-Account (to an X-Account or N-Account) gives rise to the payment by the transferor to the Clearer or the Domiciliary Agent, as appropriate, of withholding tax on the accrued interest calculated from the last Interest Payment Date up to the transfer date;
- (b) a transfer (from an X-Account or N-Account) to an N-Account gives rise to the refund by the Clearer or the Domiciliary Agent, as appropriate, to the transferee of withholding tax on the accrued interest calculated from the last Interest Payment Date up to the transfer date; and
- (c) transfers of Treasury Notes between two X Accounts do not give rise to any adjustment on account of withholding tax.

▪ INCOME TAX

A. Belgian resident individuals

For Noteholders who are subject to Belgian personal income tax, the withholding tax will normally constitute the final tax in relation to the interest or accrued interest on which it is levied.

Provided the Treasury Notes are not allocated to the professional activity of the individual, any capital gain upon a sale of Notes to a party other than the Issuer is in principle tax exempt (unless the tax authorities can prove that the capital gain does not result from the normal management of the individual's private estate and except for that part of the sale price attributable to accrued interest).

Capital losses on Treasury Notes not allocated to the professional activity of the individual will usually not be deductible.

B. Belgian resident companies

Noteholders who are subject to Belgian corporate income tax will be liable to tax in Belgium on the income from the Treasury Notes and on capital gains realized upon the disposal of the Notes.

Capital losses realized upon the disposal of the Treasury Notes will normally be tax deductible.

C. Belgian resident legal entities

For Noteholders who are subject to Belgian legal entities income tax, the withholding tax will constitute the final tax in relation to the interest or accrued interest on which it is levied. The Noteholders will not be subject to income tax on capital gains realized upon the disposal of the Treasury Notes (except for that part of the sale price attributable to accrued interest).

In the case of Belgian resident legal entities which are Tax Eligible Holders, no withholding tax will be levied due to the fact that they hold the Treasury Notes through an X-Account in the Clearing System. As a result, these Noteholders (e.g. municipalities) will have to file a withholding tax return and pay withholding tax themselves.

Capital losses on Treasury Notes held by Belgian resident legal entities will usually not be deductible.

D. Non-residents of Belgium

Noteholders who are non-residents for Belgian tax purposes and who are not holding the Treasury Notes through a Belgian establishment nor investing in the Notes in the framework of their Belgian professional activity, will not be liable to tax in Belgium on income or capital gains (except, if applicable, in the form of withholding tax) by reason only of the acquisition, ownership or disposal of the Notes.

▪ TRANSFER TAX

Pursuant to Article 126-1-9° of the Code on Miscellaneous Duties and Taxes (*Code des droits et taxes divers / Wetboek diverse rechten en taksen*), no tax on Stock Exchange Transactions (*taxe sur les opérations de bourse / taks op beursverrichtingen*) applies on transactions involving Treasury Notes in Belgium.

3. SAVINGS DIRECTIVE

Under EC Council Directive 2003/48/EC on the taxation of savings income (the "**Directive**"), Member States are required to provide to the tax authorities of another Member State details of payments of interest (or similar income) paid by a person within its jurisdiction to an individual resident in that other Member State or to certain limited types of entities established in that other Member State. However, for a transitional period, Luxembourg and Austria are instead required (unless during that period they elect otherwise) to operate a withholding system in relation to such payments (the ending of such transitional period being dependent upon the conclusion of certain other agreements relating to information exchange with certain other countries). A number of non-EU countries and territories including Switzerland have adopted similar measures (a withholding system in the case of Switzerland).

On 15 September 2008 the European Commission issued a report to the Council of the European Union on the operation of the Directive, which included the Commission's advice on the need for changes to the Directive. On 13 November 2008 the European Commission published a more detailed proposal for amendments to the Directive, which included a number of suggested changes. The European Parliament approved an amended version of this proposal on 24 April 2009. If any of the proposed changes are made in relation to the Directive, they may amend or broaden the scope of the requirements described above.

SELLING RESTRICTIONS

1. General

No action has been taken or will be taken by the Issuer or the Dealer that would permit a public offering of any of the Treasury Notes in any country or jurisdiction where action for that purpose is required.

Accordingly, each of the Issuer and the Dealer represents, warrants and agrees that it will observe all applicable laws and regulations in any jurisdiction in which it may offer, sell or deliver Treasury Notes and it will not directly or indirectly offer, sell, resell, re-offer or deliver Treasury Notes or distribute any disclosure document (including but not limited to the Prospectus), offering circular, advertisement or other offering material in any country or jurisdiction except under circumstances that will result, to the best of its knowledge and belief, in compliance with all applicable laws and regulations.

The Treasury Notes shall and may not be offered or sold (either on issue or at any time thereafter) to investors in any jurisdiction where such offer or sale would not be authorised, constitute a public offering of securities, or would require any action.

Treasury Notes will only be sold to investors keeping the purchased Treasury Notes on a securities account opened with the Clearer or with a Custodian and Zero-coupon Notes having an original maturity over one year may only be offered or sold to purchasers that are holding such Treasury Notes on an X-account (Cfr. article 2, §3, 2°, second dash juncto article 3, paragraph 3 of the Royal Decree of 26 May 1994).

Potential purchasers will undertake to comply with all applicable laws and regulations of such jurisdictions and will accept responsibility accordingly.

More specifically, but without limitation, potential purchasers are hereby informed that:

2. Belgium

In Belgium, there are no restrictions in respect of the purchase and transfer of the Treasury Notes other than (i) that the Treasury Notes are to be kept at all times on a securities account with a Custodian, and (ii) no issuance or transfer of Treasury Notes may result in any investor holding Treasury Notes for an amount less than the minimum amount stipulated by or established in accordance with Article 4 of the Law and/or stipulated by or established in accordance with Article 6 of the Royal Decree. The Programme provides for Notes to be issued in the minimum amount pursuant to Article 4 of the Law (EUR 250,000 (or its equivalent in any Foreign Currency)), or such other denominations as may be determined by the regulations, including the Law and the Royal Decree. Notes may be issued to investors which qualify as public administrations (*administrations publiques/overheden*) with the minimum denomination pursuant to article 6 of the Royal Decree (EUR 100,000) (or its equivalent in any Foreign Currency)).

3. United States of America

The Treasury Notes have not been and will not be registered under the United States Securities Act of 1933, as amended (the "**Securities Act**") and the Treasury Notes may not be offered or sold within the United States. The Issuer and each Dealer represents and agrees that it has offered and sold, and will offer and sell, Treasury Notes only outside the United States in accordance with Rule 903 of Regulation S under the Securities Act ("**Regulation S**"). Accordingly, the Issuer and each Dealer represents and agrees that neither it, nor its affiliates nor any person acting on its or their behalf has engaged or will engage in any directed selling efforts with respect to the Treasury Notes. Terms used in this paragraph have the meanings given to them by Regulation S.

The Treasury Notes will be issued and delivered outside the United States and its possessions in connection with their original issuance. The Dealer has not offered, sold or delivered, and will not offer, sell or deliver, directly or indirectly, such Treasury Notes within the United States or its possessions in connection with their original issuance. Further, in connection with the original issuance of such Treasury Notes the Dealer has not communicated, and will not communicate, directly or indirectly, with a prospective purchaser if such purchaser is within the United States or its possessions and will not otherwise involve its U.S. office in the offer or sale of such Treasury Notes. Terms used in this paragraph have the meanings given to them by the U.S. Internal Revenue Code of 1986 and regulations thereunder, including U.S. Treas. Reg. §1.163-5(c)(2)(i)(C).

4. The United Kingdom

The Dealer has represented and agreed, and each further Dealer appointed under the Programme will be required to represent and agree, that:

(a) in relation to any Treasury Notes which have a maturity of less than one year, (i) it is a person whose ordinary activities involve it in acquiring, holding, managing or disposing of investments (as principal or agent) for the purposes of its business and (ii) it has not offered or sold and will not offer or sell any Treasury Notes other than to persons whose ordinary activities involve them in acquiring, holding, managing or disposing of investments (as principal or as agent) for the purposes of their businesses or who it is reasonable to expect will acquire, hold, manage or dispose of investments (as principal or agent) for the purposes of their businesses where the issue of the Treasury Notes would otherwise constitute a contravention of Section 19 of the Financial Services and Markets Act 2000 (the FSMA) by the Issuer;

(b) it has only communicated or caused to be communicated and will only communicate or cause to be communicated an invitation or inducement to engage in investment activity (within the meaning of Section 21 of the FSMA) received by it in connection with the issue or sale of any Treasury Notes in circumstances in which Section 21(1) of the FSMA does not apply to the Issuer; and

(c) it has complied and will comply with all applicable provisions of the FSMA with respect to anything done by it in relation to any Treasury Notes in, from or otherwise involving the United Kingdom.

5. Other Restrictions and Amendments to Restrictions

The Pricing Supplement in respect of the relevant Treasury Notes may contain additional selling restrictions as agreed between the Issuer and the Dealer or may amend the above selling restrictions as they apply to such Treasury Notes.

EXEMPT ACCOUNT HOLDERS

ARTICLE 4 OF THE ROYAL DECREE OF 26 MAY 1994 AS AMENDED AS AT THE DATE OF THIS PROSPECTUS. ANY POTENTIAL PURCHASER OF TREASURY NOTES SHOULD CONSULT WITH HIS TAX ADVISER PRIOR TO ANY INVESTMENT

Les catégories de personnes pour lesquelles, conformément à l'article 16, 1° de la loi, il est renoncé à la perception du précompte mobilier sont:

1. les sociétés résidentes, visées à l'article 2, §1, 5°, b) du Code des impôts sur les revenus 1992;
2. sans préjudice de l'application de l'article 262, 1° et 5° du Code des impôts sur les revenus 1992, les institutions, associations ou sociétés, visées à l'article 2, §3 de la loi du 9 juillet 1975 relative au contrôle des sociétés d'assurances, autres que celles visées au 1° et 3°;
3. les organismes para-étatiques de sécurité sociale ou les organismes y assimilés visés à l'article 105, 2°, de l'AR/CIR 92;
4. les épargnants non-résidents visés à l'article 105, 5° du même arrêté;
5. les fonds de placement visés à l'article 115 du même arrêté;
6. les contribuables visés à l'article 227, 2° du Code des impôts sur les revenus 1992 qui sont assujettis à l'impôt des non-résidents conformément à l'article 233 du même Code, et qui ont affecté les capitaux productifs des revenus à l'exercice de leur activité professionnelle en Belgique;
7. l'Etat belge, pour ses placements exempts de précompte mobilier, conformément à l'article 265 du Code des impôts sur les revenus 1992;
8. les organismes de placement collectif de droit étranger qui sont un patrimoine indivis géré par une société de gestion pour compte des participants lorsque leurs parts ne font pas l'objet d'une émission publique en Belgique et ne sont pas commercialisées en Belgique.
9. les sociétés résidentes non visées au 1° dont l'activité exclusive ou principale consiste en l'octroi de crédits et prêts.
10. uniquement en ce qui concerne les revenus des titres émis par les personnes morales qui font partie du secteur des administrations publiques au sens du système européen de comptes nationaux et régionaux (SEC) pour l'application du Règlement (CE) N° 3605/93 du Conseil, du 22 novembre 1993, relatif à l'application du protocole sur la procédure concernant les déficits excessifs annexé au Traité instituant la Communauté européenne, les personnes morales qui font partie du secteur des administrations publiques mentionné ci-dessus.
Dans le système de liquidation les

De categorieën van personen waarvoor overeenkomstig artikel 16, 1° van de wet wordt afgezien van de inning van de roerende voorheffing zijn:

1. de binnenlandse vennootschappen, bedoeld in artikel 2, §1, 5°, b) van het Wetboek van de inkomstenbelastingen 1992;
2. onverminderd de toepassing van artikel 262, 1° en 5° van het Wetboek van de inkomstenbelastingen 1992, de instellingen, verenigingen of vennootschappen, bedoeld in artikel 2, §3 van de wet van 9 juli 1975 betreffende de controle der verzekeringsondernemingen, andere dan deze bedoeld onder 1° en 3°;
3. de parastatale instellingen voor sociale zekerheid of ermede gelijkgestelde instellingen bedoeld in artikel 105, 2° KB/WIB 92;
4. de spaarders niet-inwoners bedoeld in artikel 105, 5° van hetzelfde besluit;
5. de beleggingsfondsen bedoeld in artikel 115 van hetzelfde besluit;
6. de belastingplichtigen bedoeld in artikel 227, 2° van het Wetboek van de inkomstenbelastingen 1992 die de inkomstgevendende kapitalen hebben aangewend voor de uitoefening van hun beroepswerkzaamheid in België en onderworpen zijn aan de belasting van de niet-inwoners overeenkomstig artikel 233 van hetzelfde Wetboek;
7. de Belgische Staat, voor zijn beleggingen die van de roerende voorheffing zijn vrijgesteld overeenkomstig artikel 265 van het Wetboek van de inkomstenbelastingen 1992;
8. de instellingen voor collectieve belegging naar buitenlands recht die een onverdeeld vermogen zijn dat een beheersvennootschap beheert voor rekening van de deelnemers, wanneer hun rechten van deelneming niet openbaar in België worden uitgegeven en niet in België worden verhandeld.
9. de binnenlandse vennootschappen, die niet bedoeld worden in 1°, waarvan de activiteit uitsluitend of hoofdzakelijk bestaat in het verlenen van kredieten en leningen.
10. uitsluitend wat betreft de inkomsten op effecten uitgegeven door rechtspersonen die deel uitmaken van de sector overheid in de zin van het Europees systeem van nationale en regionale rekeningen (ESR), voor de toepassing van de Verordening (EG) Nr. 3605/93 van de Raad van 22 november 1993 betreffende de toepassing van het aan het Verdrag tot oprichting van de Europese Gemeenschap gehechte Protocol betreffende de procedure bij buitensporige tekorten, de rechtspersonen die deel uitmaken van de vermelde sector overheid.
Binnen het vereffeningstelsel houden de bovenvermelde categorieën van instellingen en

The categories of persons for whom withholding tax is not levied, in accordance with Article 16, 1° of the law, are:

1. resident companies, referred to in Article 2, §1, 5°, b) of the Belgian Income Tax Code 1992;
2. without prejudice to the application of Article 262, 1° and 5° of the Belgian Income Tax Code 1992, the institutions, associations or companies, referred to in Article 2, §3 of the Law of 9 July 1975 on the supervision of insurance companies, other than those referred to under 1° and 3°;
3. semi-public social security institutions or institutions similar thereto (referred to in Article 105, 2° of the Royal Decree to the Belgian Income Tax Code 1992;
4. non-resident investors referred to in Article 105, 5° of the same Royal Decree;
5. investment funds referred to in Article 115 of the same Royal Decree;
6. the taxpayers referred to in Article 227, 2° of the Belgian Income Tax Code 1992 which are liable to non-resident income tax in accordance with Article 233 of the same Code, and which have allocated the capital producing the revenue to the exercise of their professional activity in Belgium;
7. the Belgian State, for its investments exempt from withholding tax, in accordance with Article 265 of the Belgian Income Tax Code 1992;
8. foreign mutual investment funds, managed by a management company on behalf of the participants, provided that the participation certificates are not offered publicly in Belgium and are not traded in Belgium.
9. resident companies not referred to under 1° whose sole or main activity consists in the granting of credits and loans.
10. only for the income from debt securities issued by legal entities belonging to the public sector within the meaning of the European system of national and regional accounts (EAS) for the application of Regulation (EC) N° 3605/93 of the Council of 22 November 1993, concerning the application of the Protocol on the procedure in case of excessive deficits attached to the Treaty establishing the European Community, the legal entities which belong to the public sector referred to above.

organismes et personnes précités détiennent leurs titres propres uniquement sur les comptes exonérés, visés à l'article 1er, 5° de la loi, que les comptes soient détenus en Belgique ou à l'étranger.

personen hun eigen effecten uitsluitend aan op vrijgestelde rekeningen, bedoeld in artikel 1, 5° van de wet, ongeacht of de rekeningen in België of in het buitenland worden aangehouden.

Within the clearing system the aforementioned organisations and persons hold their own securities only on exempt accounts, referred to in Article 1, 5° of the law, whether the accounts are held in Belgium or abroad.

The French and Dutch version of the above mentioned Art 4 prevails, the English version being a free translation that is only included here for information purposes.

GENERAL INFORMATION

1. The Issuer has obtained all necessary consents, approvals and authorisations in Belgium in connection with the establishment of the Programme. The Prospectus was approved by the Budget and Finance Minister (*Ministre du Budget et des Finances*) of the Issuer.
2. Issues of Notes under the Programme will be approved by the Budget and Finance Minister of the Issuer. The Budget and Finance Minister of the Issuer shall not proceed with any issue of Notes unless, and to the extent, he has been authorised to do so by a budget or other decree enacted by the Parliament of the Issuer and in effect at the time of the issue.

Before making any issue under the Programme, the Issuer will obtain all necessary consents, approvals and authorisations and will proceed with the issue in compliance with, in particular, Articles 49, 50, 51 and 52 of the Law of 16 January 1989 on the financing of the communities and regions (*loi spéciale relative au financement des Communautés et Régions*), as amended from time to time. In particular:

- (a) in the case of public issues of Notes, the Issuer will comply with the calendar set by the Federal Government for the public issues of debt by all federal entities (following consultation of the Community and Regional Governments) and the Federal Minister of Finance will have given his consent to the issue;
 - (b) in the case of private issues of Notes and the issue of short-term Notes, the Issuer will notify in advance the Federal Minister of Finance; if the Federal Minister of Finance has sought the advice of the expert group within the High Council of Finance on the need to limit the borrowing capacity of the Issuer in order to protect the economic and monetary union, avoid internal and external monetary imbalances and a structural deterioration of the financing needs of the Issuer, or if the expert group has issued such advice at its own initiative and as a consequence the Federal Government has decided to suspend the Issuer's authority to borrow for a period of up to two years, the Federal Minister of Finance will have given his consent to the issue.
3. The execution of the annual budget of the Issuer is subject to a review by the National Audit Office ("*Cour des comptes*"), a separate institution that advises the Parliament of the Issuer. The definitive budget decree ("*décret portant règlement définitive du budget*") is adopted by the Parliament of the Issuer after verification by the National Audit Office.

INTENTIONALLY LEFT BLANK

ISSUER

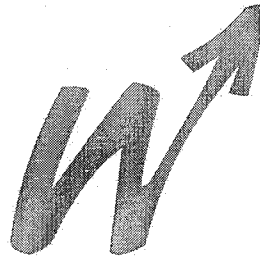

RÉGION WALLONNE

REGION WALLONNE

Att: Direction du Financement
Boulevard du Nord, 8
B-5000 Namur
Belgium

ARRANGER, CALCULATION AGENT, DEALER AND DOMICILIARY AGENT



BNP PARIBAS
FORTIS

BNP Paribas Fortis
Montagne du Parc 3
1000 Brussels
Belgium
